



teykos[®]

catalogo
generale



teykos[®]

Un mondo di idee per l'arredo casa.



Teykos by Colori in Casa è un'azienda specializzata nel settore della decorazione parete e delle pavimentazioni. Ad un mercato in continua evoluzione l'azienda ha sempre risposto adeguando il proprio assortimento con proposte innovative, in grado di soddisfare esigenze specifiche ed attuali. Per fare ciò Teykos pone molta attenzione alla ricerca di prodotti dal design contemporaneo con caratteristiche innovative e performanti.

La nuova collezione di cornici e profili in duro-polimero va ad arricchire la proposta commerciale con una gamma dalle molteplici possibilità di combinazione. Boiserie, sgusci, profili LED, battiscopa e parasigoli, pannelli per rivestimento pareti, oltre ad una serie di fregi e decori che rende la collezione in Polyforte completa e flessibile per ogni esigenza.

Di notevole interesse la serie di pavimenti e rivestimenti per esterni con la due collezioni Classic e Protect, mentre la collezione di pavimenti per interno è stata completamente trasformata essendo realizzata con il nuovo materiale SPC con polvere di pietra e materassino integrato, rivoluzionata nella sua interezza con nuove colorazioni e decori sempre più attuali.

Teykos by Colori in Casa is a company specialized in wall decoration and flooring sector. The company has always responded to a constantly evolving market by adapting its assortment with innovative proposals, capable of satisfying specific and current needs. To do this, Teykos pays more attention at searching contemporary design products with innovative and performing characteristics.

The new collection of hard-polymer frames and profiles enriches the commercial proposal with a range with multiple combination possibilities. Boiserie, coves, LED profiles, skirting boards and corner guards, wall covering panels, as well as a series of friezes and decorations that make the Polyforte collection complete and flexible for every need. The collection of outdoor floors and walls with the two lines Classic and Protect is very interesting, in the main time the collection of indoor floors has been completely transformed, we are chosen a line made up of a new material SPC with stone powder and integrated mattress, which revolutionizes the range entirely introducing new colors and more and more current decorations.





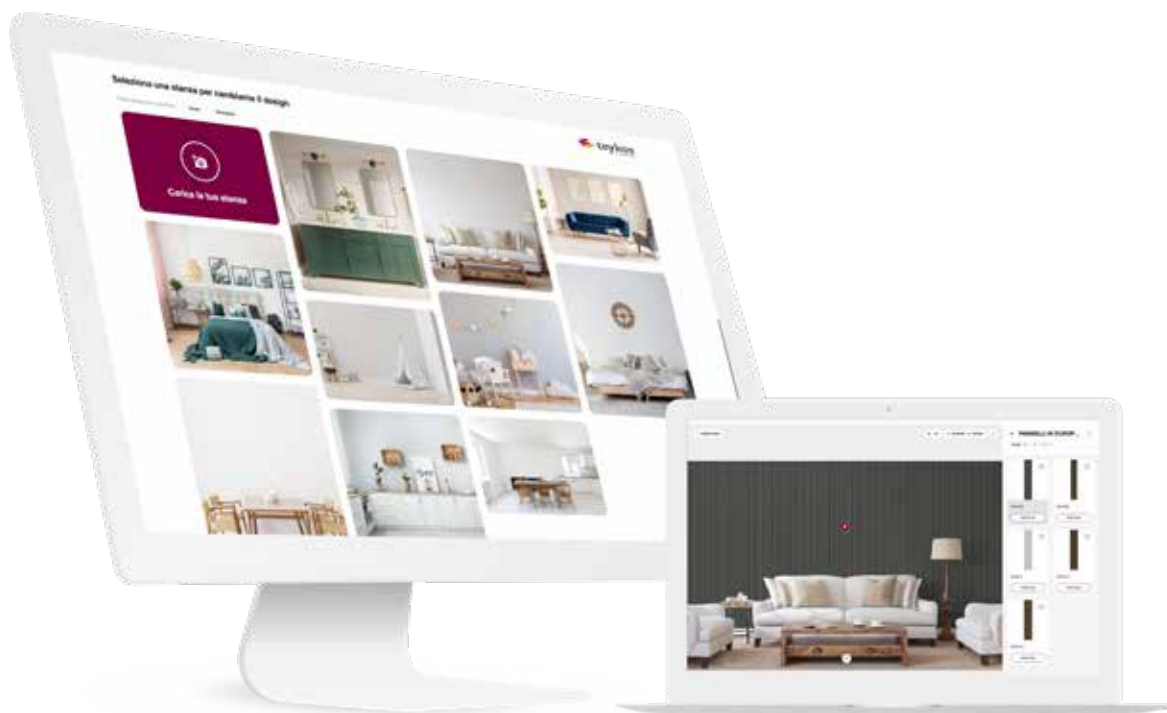

NUOVE SOLUZIONI DIGITALI AVANZATE

Teykos Colori in Casa ha realizzato un'interfaccia di programmazione innovativa, per dare la possibilità ai clienti di personalizzare i propri ambienti, con facilità e velocità. Prima di ordinare una pavimentazione o un rivestimento, si avrà la possibilità di testare direttamente sulla foto scattata al proprio spazio domestico, i vari prodotti messi a disposizione dall'App presente sul sito nostro sito web.

FACILE ED INTUITIVO IN TRE MOSSE

- 1 - Scattare la foto del proprio ambiente.
- 2 - Andare su www.teykos.it e caricare la foto scattata con il cellulare nella sezione APP.
- 3 - Personalizzare il proprio ambiente con i rivestimenti a disposizione sull'applicazione e scegliere i prodotti che si abbinano meglio al proprio ambiente.

I prodotti presenti sull'APP saranno implementati nel tempo con nuove proposte e tipologie di articoli.

NEW ADVANCED DIGITAL SOLUTIONS

Teykos Colori in Casa has created an innovative programming interface, as to give customers the opportunity to customize their spaces quickly and easily. Before buying a flooring or a coating, you will have the opportunity to test the various products made available by the App directly on the photo taken to your home space

EASY AND INTUITIVE IN THREE MOVES

- 1 - Take a picture of your space.
- 2 - Go to www.teykos.it and upload the photo taken with your mobile phone in the APP section.
- 3 - Customize your space with the coatings available on the application and choose the products that best match your environment.

The products on the APP will be implemented over time with new proposals and types of items.



INQUADRA IL QR CODE
E PERSONALIZZA I TUOI AMBIENTI.

*FRAME THE QR CODE
AND CUSTOMIZE YOUR SPACES.*

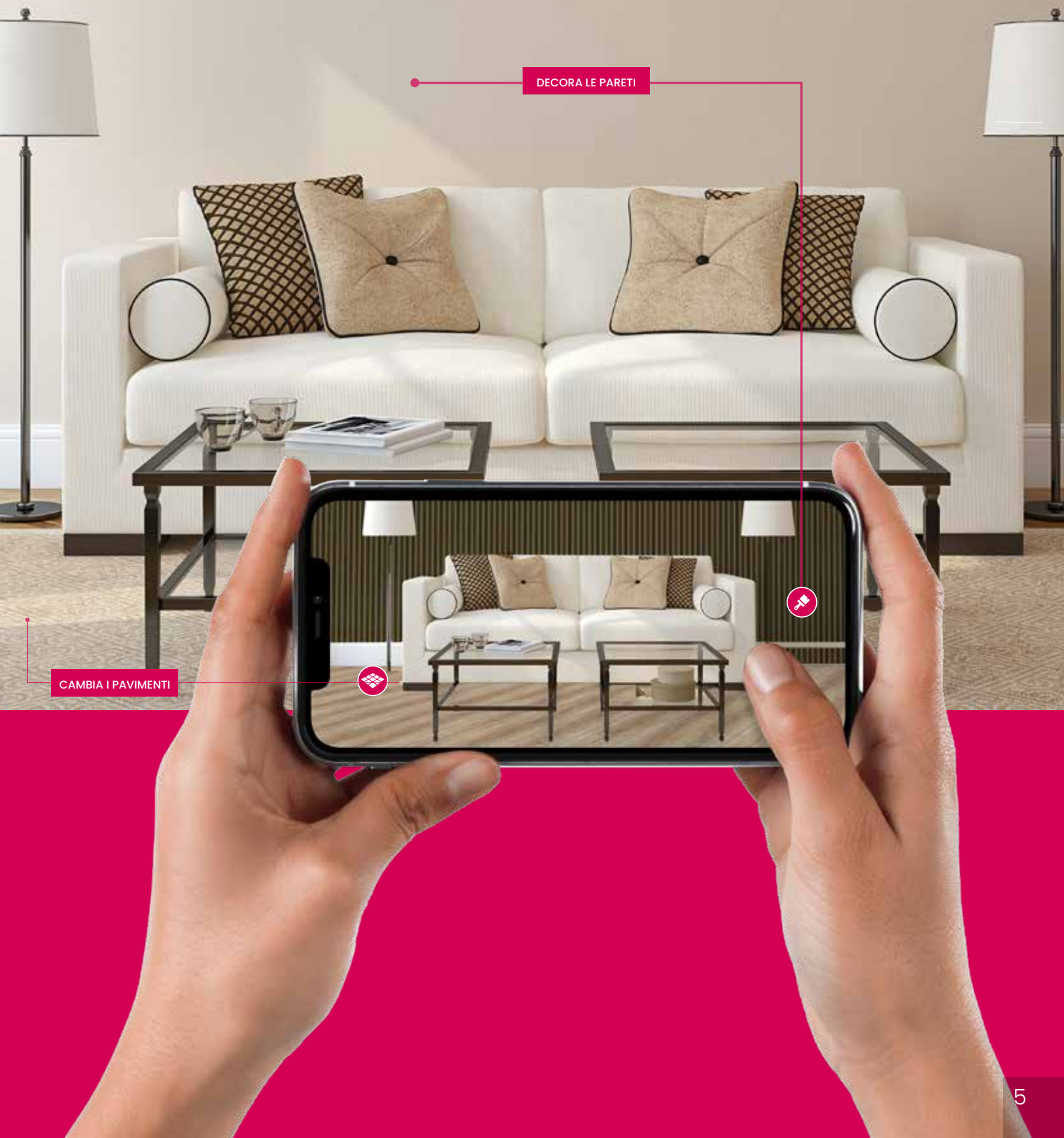

DECORA LE PARETI

CAMBIA I PAVIMENTI



Polyforte / Polyforte

Boiserie / *Boiserie*
Cornici boiserie / *Boiserie frames*
Cornici / *Frames*
Cassettonato / *Coffering Elements*
Lesene, liste da porta e finestre / *Pilasters, door frames and windows*
Cornici LED / *LED frames*
Sgusci, composti e composti LED / *Coving elements and composed coving LED elements*
Battiscopa LED / *LED Skirting boards*
Battiscopa moderni / *Modern skirting boards*
Battiscopa classici / *Classic skirting boards*
Battiscopa rivestiti / *Covered skirting boards*
Coprimarmo e coprimarmo rivestiti / *Marble cover and covered marble cover*
Paraspigoli e paraspigoli rivestiti / *Edge protectors and covered edge protectors*
Laccature RAL per profili / *RAL lacquers for profiles*
Rivestimenti murali / *Wall coverings*

Pag. 7

Pag. 10 - 73
Pag. 34 - 37
Pag. 74
Pag. 76
Pag. 78
Pag. 86
Pag. 90
Pag. 96
Pag. 98
Pag. 102
Pag. 104
Pag. 108
Pag. 110
Pag. 112
Pag. 114

Rivestimenti, pavimenti WPC e prato / Wall tiles, WPC floors and lawn

Rivestimenti murali e pavimenti da esterno / *Wall coverings and outdoor floors*
Prato / *Grass*

Pag. 126

Pag. 128
Pag. 138

Pavimenti da interno / Indoor floors

Teystrong Plus AC5
Teystrong Plus AC4
Teydry AC5
Teyself
Sottopavimenti e accessori / *Subfloors and accessories*
Sistemi di posa / *Laying systems*

Pag. 140

Pag. 142
Pag. 146
Pag. 150
Pag. 153
Pag. 156
Pag. 158

Polistirolo / Styrofoam

Cornici estruse / *Extruded frames*
Cornici decorate / *Decorated frames*
Rosoni e mensole / *Ceiling rosettes and corbels*
Lesene e semicolonne / *Pilasters and half columns*
Pannelli soffitto / *Ceiling panels*
Travi / *Beams*
Isolanti / *Insulators*

Pag. 160

Pag. 162
Pag. 164
Pag. 165
Pag. 168
Pag. 170
Pag. 172
Pag. 173

Collanti / Adhesives

Pag. 174

Legenda per boiserie / Legenda for boiserie

Fornitura del pannello assemblato con cartongesso.
Supply of the assembled panel plasterboard.

Fornitura del telaio assemblato.
Supply of the assembled frame.

Fornitura degli elementi singoli del telaio pretagliati.
Supply of pre-cut single frame elements.

Polyforte

È un materiale innovativo ed eco-compatibile, ottenuto attraverso un processo di estrusione di polistirene con gradi diversi di durezza ed appositamente miscelato. Nasce così un prodotto ad alta densità che, con una grande facilità di lavorazione, è perfetto anche per il fai-da-te e permette di creare infinite soluzioni.

I VANTAGGI:

- Versatile, leggero e resistente agli urti.
- Non teme l'umidità e l'acqua (ideale anche per bagni e centri benessere).
- Minima reazione agli sbalzi di temperatura nell'ambiente.
- Facilità e velocità di lavorazione (taglio e preparazione di giunti angolari).
- È verniciabile e resiste alla pittura multipla.
- Minimi restringimenti lineari e trasversali.
- Dettagli perfetti, ben definiti senza sbavature.

Polyforte

It is an innovative and eco-friendly material, obtained through an extrusion process of polystyrene with different degrees of hardness and specially mixed.

This creates a high density product that, with great ease of processing, is also perfect for DIY and allows you to create infinite solutions

THE ADVANTAGES:

- Versatile, lightweight and impact resistant.
- Waterproof (ideal also for bathrooms and wellness centers).
- Minimal reaction to temperature changes.
- Easy and speed of processing (cutting and preparation of joints angular).
- It is paintable and resistant to painting multiple.
- Minimum linear shrinkage and transverse.
- Perfect details, well defined without burrs.



Boiserie

Nell'arredamento contemporaneo la boiserie assume un valore estetico importante e consente di dare ritmo agli spazi interni e di armonizzare l'arredamento. I giochi grafici di linee ed ombre creati dalle composizioni conferiscono agli ambienti un grande impatto decorativo, sia nello stile classico che moderno. La nostra collezione prevede una vasta gamma di profili realizzati in Polyforte e adatti a molti tipi di arredo. Vengono proposte soluzioni che permettono qualsiasi tipo di personalizzazione, attraverso la fornitura di articoli già assemblati, compreso il pannello in cartongesso, pronti per essere installati, oppure pre-tagliati. Quindi praticità e velocità di montaggio per ottenere composizioni che trasformeranno gli spazi della casa.

Boiserie

In contemporary furniture, boiserie takes on an important aesthetic value and allows you to give rhythm to the interior spaces and to harmonize the decor. The graphic games of lines and shadows created by the compositions give to spaces a great decorative impact, both in the classic and modern style. Our collection includes a wide range of profiles made up of Polyforte and suitable for many types of furniture. We propose different solutions that allow many type of customization, through the supply of items already assembled, including plasterboard, ready to be installed, or pre-cut. That is to say easy and quickly assembly to obtain compositions that will transform the spaces of the house.



Boiserie Doppia versione Double version

- DPF3824 *** cm 30x140 pannello assemblato con cartongesso / assembled panel with plasterboard
- DPF3947 ** cm 30x140 telaio assemblato / assembled frame
- DPF3825 *** cm 30x60 pannello assemblato con cartongesso / assembled panel with plasterboard
- DPF3948 ** cm 30x60 telaio assemblato / assembled frame
- DPF3826 *** cm 45x140 pannello assemblato con cartongesso / assembled panel with plasterboard
- DPF3949 ** cm 45x140 telaio assemblato / assembled frame
- DPF3827 *** cm 45x60 pannello assemblato con cartongesso / assembled panel with plasterboard
- DPF3950 ** cm 45x60 telaio assemblato / assembled frame



SCHEMA DI MONTAGGIO / ASSEMBLY SCHEME

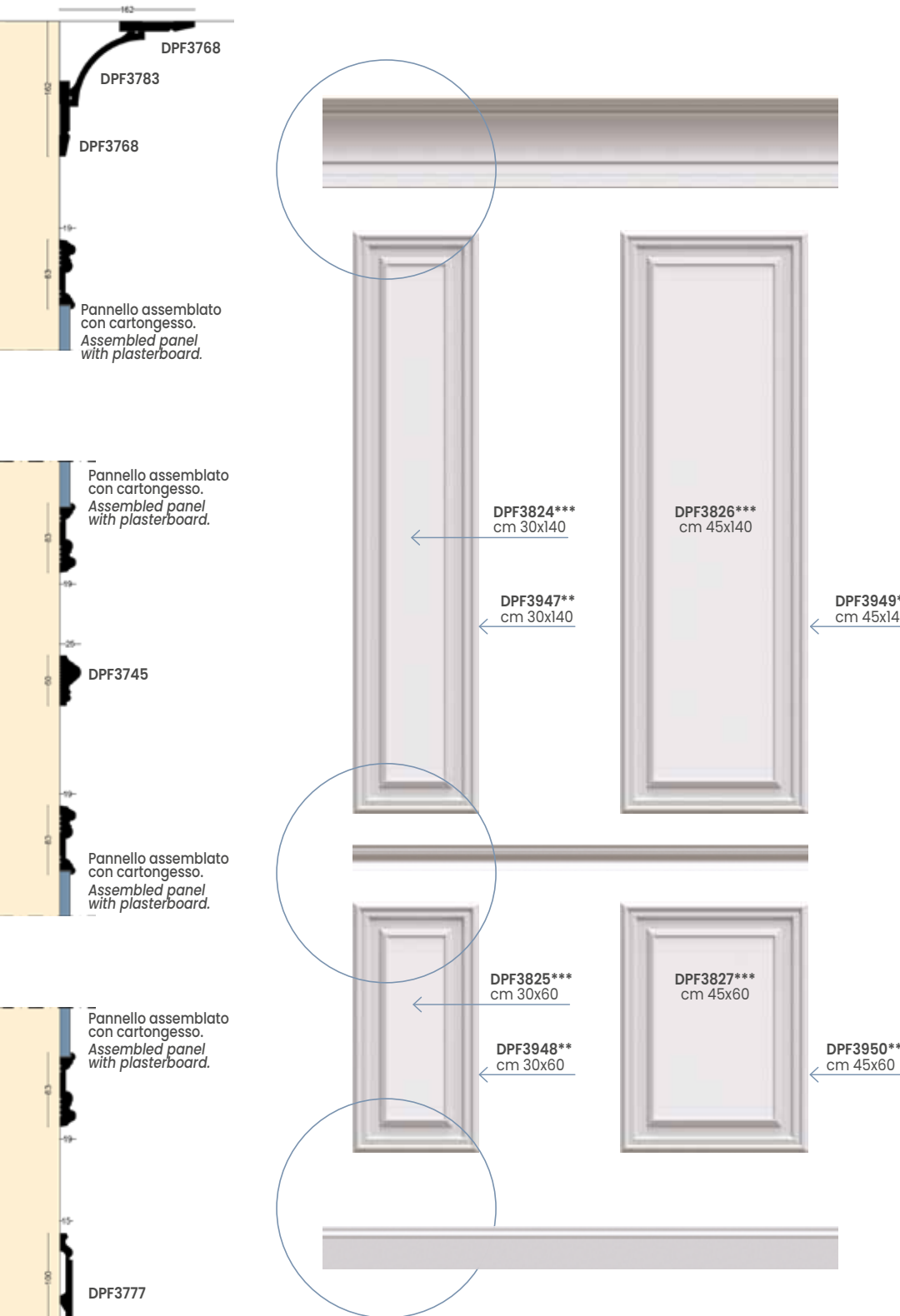

TELAIO E PANNELLO
ASSEMBLATO CON
FRAME AND PANEL
ASSEMBLED WITH
DPF3755

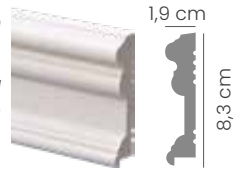

Telai pannelli
con cartongesso.
Panel frames
plasterboard.



- 01 DPF3777 Battiscopa/Skirting boards - Pag. 102
- 02 DPF3825*** Pannello Boiserie - Pag. 10
- 03 DPF3831*** Pannello Boiserie - Pag. 102
- 04 DPF3745 Marcapiano /String course - Pag. 35

- 05 DPF3824*** Pannello Boiserie - Pag. 10
- 06 DPF3830*** Pannello Boiserie - Pag. 12
- 07 DPF3783 Sguscio composto /Composed coving element - Pag. 90
- 08 DPF3768 Sguscio composto /Composed coving element - Pag. 99

 Collanti dedicati. Per quantità vedi listino.
Dedicated glues. For quantity see price list.
COL3589-COL3590
COL3591 (sigillante / sealant)

Vedi pagine
collanti
See gluing pages
176 - 177



FACILE INSTALLAZIONE
EASY INSTALLATION



VERNICIABILE
PAINTABLE



IMPERMEABILE
WATERPROOF

Boiserie Doppia versione Double version

DPF 3828 ***	cm 60x140	pannello assemblato con cartongesso / assembled panel with plasterboard
DPF 3951 **	cm 60x140	telaio assemblato / assembled frame
DPF 3829 ***	cm 60x60	pannello assemblato con cartongesso / assembled panel with plasterboard
DPF 3952 **	cm 60x60	telaio assemblato / assembled frame
DPF 3830 ***	cm 75x140	pannello assemblato con cartongesso / assembled panel with plasterboard
DPF 3953 **	cm 75x140	telaio assemblato / assembled frame
DPF 3831 ***	cm 75x60	pannello assemblato con cartongesso / assembled panel with plasterboard
DPF 3954 **	cm 75x60	telaio assemblato / assembled frame

SCHEMA DI MONTAGGIO / ASSEMBLY SCHEME

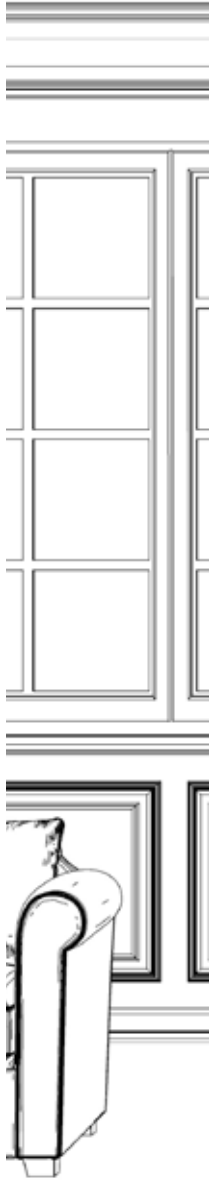
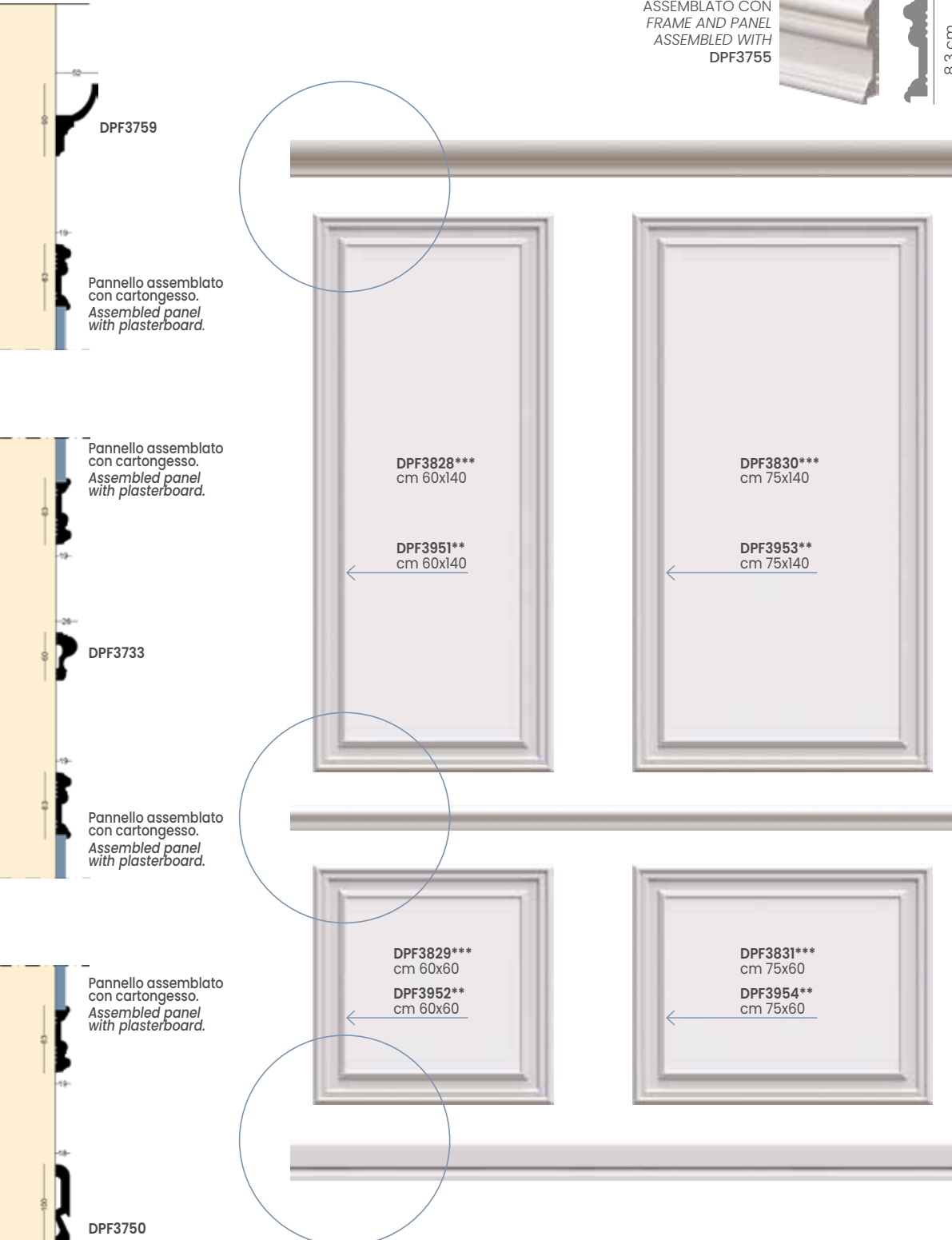

Coordinati
battiscopa LED.
Coordinate
LED skirting board.



- 01 DPF3750 Battiscopa/Skirting boards - Pag. 96
- 02 DPF3825*** Pannello Boiserie - Pag. 10
- 03 DPF3833*** Pannello Boiserie - Pag. 15
- 04 DPF3733 Marcapiano /String course - Pag. 34

- 05 DPF3824*** Pannello Boiserie - Pag. 10
- 06 DPF3832*** Pannello Boiserie - Pag. 15
- 07 DPF3759 Cornice LED / LED Frame - Pag. 86
- 08 DPF3735 Cornice / Frame - Pag. 75



 Collanti dedicati. Per quantità vedi listino.
Dedicated glues. For quantity see price list.
COL3589-COL3590
COL3591 (sigillante / sealant)

Vedi pagine
collanti
See gluing pages
176 - 177



FACILE INSTALLAZIONE
EASY INSTALLATION



VERNICIABILE
PAINTABLE



IMPERMEABILE
WATERPROOF



01 DPF3765 Battiscopa/Skirting boards - Pag. 98

02 DPF3825*** Pannello Boiserie - Pag. 10

03 DPF3833*** Pannello Boiserie - Pag. 15

04 DPF3732 Marcapiano /String course - Pag. 34

05 DPF3824*** Pannello Boiserie - Pag. 10

06 DPF3832*** Pannello Boiserie - Pag. 15

07 DPF3782 Cornice / Frame - Pag. 75

08 DPF3787 Sguscio / Coving element - Pag. 90

 Collanti dedicati. Per quantità vedi listino.
Dedicated glues. For quantity see price list.
COL3589-COL3590
COL3591 (sigillante / sealant)

Vedi pagine
collanti
See gluing pages
176 - 177



FACILE INSTALLAZIONE
EASY INSTALLATION



VERNICIABILE
PAINTABLE



IMPERMEABILE
WATERPROOF



Coordinati.
battiscopa moderni.
Coordinates.
modern skirting boards.

- DPF3832 *** cm 90x140 pannello assemblato con cartongesso / *assembled panel with plasterboard*
- DPF3955 ** cm 90x140 telaio assemblato / *assembled frame*
- DPF3833 *** cm 60x60 pannello assemblato con cartongesso / *assembled panel with plasterboard*
- DPF3956 ** cm 30x60 telaio assemblato / *assembled frame*
- DPF3834 *** cm 115x140 pannello assemblato con cartongesso / *assembled panel with plasterboard*
- DPF3957 ** cm 115x140 telaio assemblato / *assembled frame*
- DPF3835 *** cm 115x60 pannello assemblato con cartongesso / *assembled panel with plasterboard*
- DPF3958 ** cm 115x60 telaio assemblato / *assembled frame*



SCHEMA DI MONTAGGIO / ASSEMBLY SCHEME

TELAIO E PANNELLO ASSEMBLATO CON
FRAME AND PANEL ASSEMBLED WITH
DPF3755

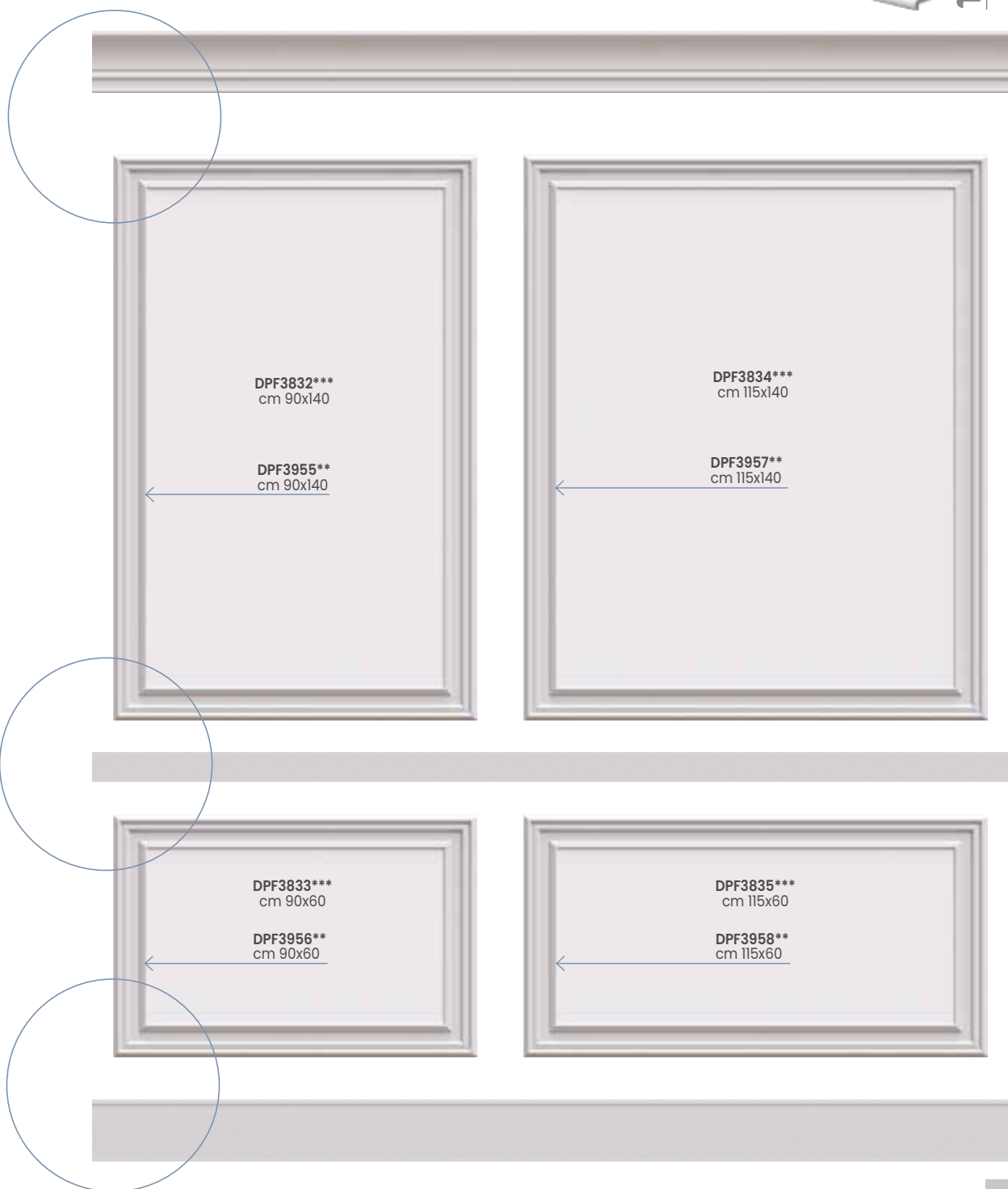
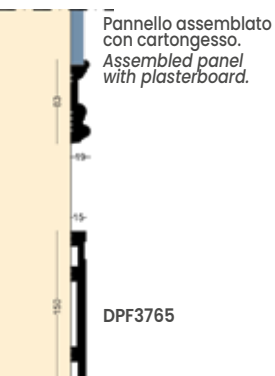
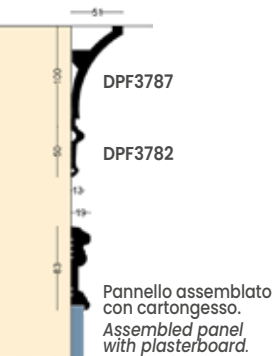



- 01 DPF3751 Battiscopa/Skirting boards - Pag. 102
- 02 DPF3833*** Pannello Boiserie - Pag. 15
- 03 DPF3732 Cornice Boiserie / Boiserie frame - Pag. 34
- 04 DPF3753 Cornice Boiserie / Boiserie Frame - Pag. 37
- 05 DPF3745 Cornice / Frame - Pag. 75
- 06 DPF3741 Cornice / Frame - Pag. 88
- 07 DPF3939** Cassettonato telaio / Coffered frame - Pag. 76



Coordinati.
battiscopa classici.
Coordinates.
classic skirting boards.



- 01 DPF3731 Battiscopa / Skirting boards - Pag. 99
- 02 DPF3831*** Pannello Boiserie / Boiserie frame - Pag. 12
- 03 DPF3732 Cornice Boiserie / Boiserie frame - Pag. 34
- 04 DPF3825*** Pannello Boiserie - Pag. 10
- 05 DPF3753 Cornice Boiserie / Boiserie frame - Pag. 37
- 06 DPF3746 Cornice / Frame - Pag. 75

 Collanti dedicati. Per quantità vedi listino.
Dedicated glues. For quantity see price list.
COL3589-COL3590
COL3591 (sigillante / sealant)

Vedi pagine
collanti
See gluing pages
176 - 177



FACILE INSTALLAZIONE
EASY INSTALLATION



VERNICIABILE
PAINTABLE



IMPERMEABILE
WATERPROOF

Boiserie

DPF3836 ** cm 30x140 telaio assemblato / assembled frame

DPF3837 ** cm 30x60 telaio assemblato / assembled frame

DPF3838 ** cm 45x140 telaio assemblato / assembled frame

DPF3839 ** cm 45x60 telaio assemblato / assembled frame

SCHEMA DI MONTAGGIO ASSEMBLY SCHEME

TELAIO ASSEMBLATO CON
ASSEMBLED FRAME WITH
DPF3754

3 cm

10,4 cm

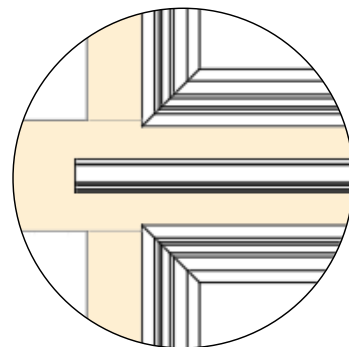
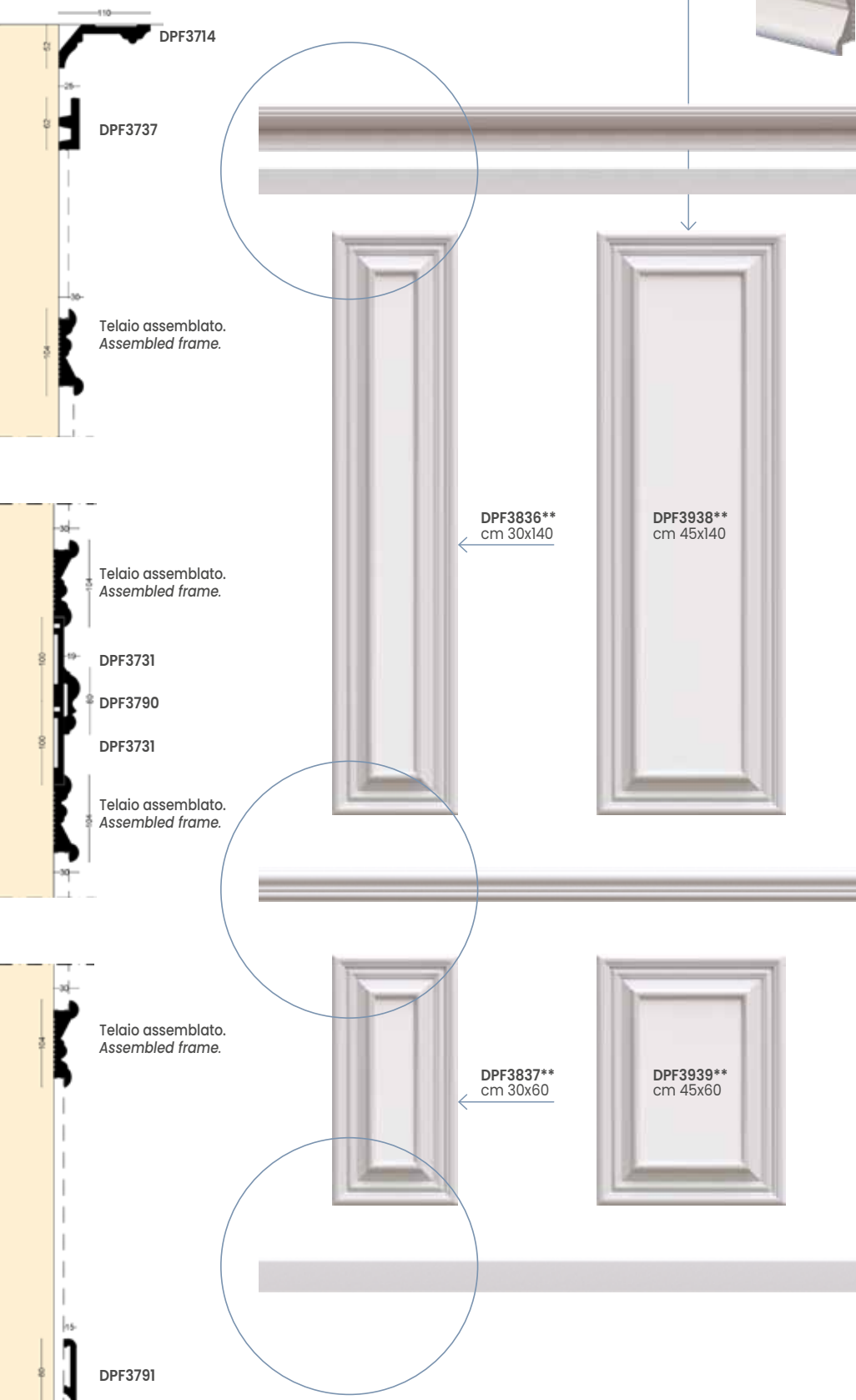

Boiserie.



01 DPF3791 Battiscopa / Skirting boards - Pag. 104

02 DPF3843** Telaio pretagliato / pre-cut frame - Pag. 21

03 DPF3731 Cornice Boiserie / Boiserie Frame - Pag. 34

04 DPF3790 Marcapiano / String course - Pag. 34

05 DPF3842** Telaio pretagliato / pre-cut frame - Pag. 21

06 DPF3757 Cornice porta / Door frame - Pag. 74

07 DPF3754 Cornice Boiserie / Boiserie frame - Pag. 34

08 DPF3737 Cornice LED / LED frame - Pag. 88

09 DPF3814 Sguscio / Coving element - Pag. 90

10 DPF3734 Cornice / Frame - Pag. 74



Collanti dedicati. Per quantità vedi listino.
Dedicated glues. For quantity see price list.
COL3589-COL3590
COL3591 (sigillante / sealant)

Vedi pagine
collanti
See gluing pages
176 - 177



FACILE INSTALLAZIONE
EASY INSTALLATION



VERNICIABILE
PAINTABLE



IMPERMEABILE
WATERPROOF

Boiserie



01 DPF3775 Battiscopa - Sguscio composto
Skirting boards - Composed coving element - Pag. 102

02 DPF3837** Telaio assemblato / assembled frame - Pag. 18

03 DPF3843** Telaio assemblato / assembled frame - Pag. 21

04 DPF3731 Cornice Boiserie / Boiserie Frame - Pag. 34

05 DPF3745 Marcapiano / String course - Pag. 35

06 DPF3754 Cornice Boiserie / Boiserie frame - Pag. 34

07 DPF3836** Telaio assemblato / assembled frame - Pag. 18

08 DPF3842** Telaio assemblato / assembled frame - Pag. 21

09 DPF3761 Sguscio composto / Composed coving element - Pag. 92

10 DPF3734 Cornice / Frame - Pag. 74



Sgusci composti.
Coving elements.

DPF3840 ** cm 60x140 telaio assemblato / assembled frame

DPF3841 ** cm 60x60 telaio assemblato / assembled frame

DPF3842 ** cm 75x140 telaio assemblato / assembled frame

DPF3843 ** cm 75x60 telaio assemblato / assembled frame



SCHEMA DI MONTAGGIO / ASSEMBLY SCHEME

TELAIO ASSEMBLATO CON
ASSEMBLED FRAME WITH
DPF3754

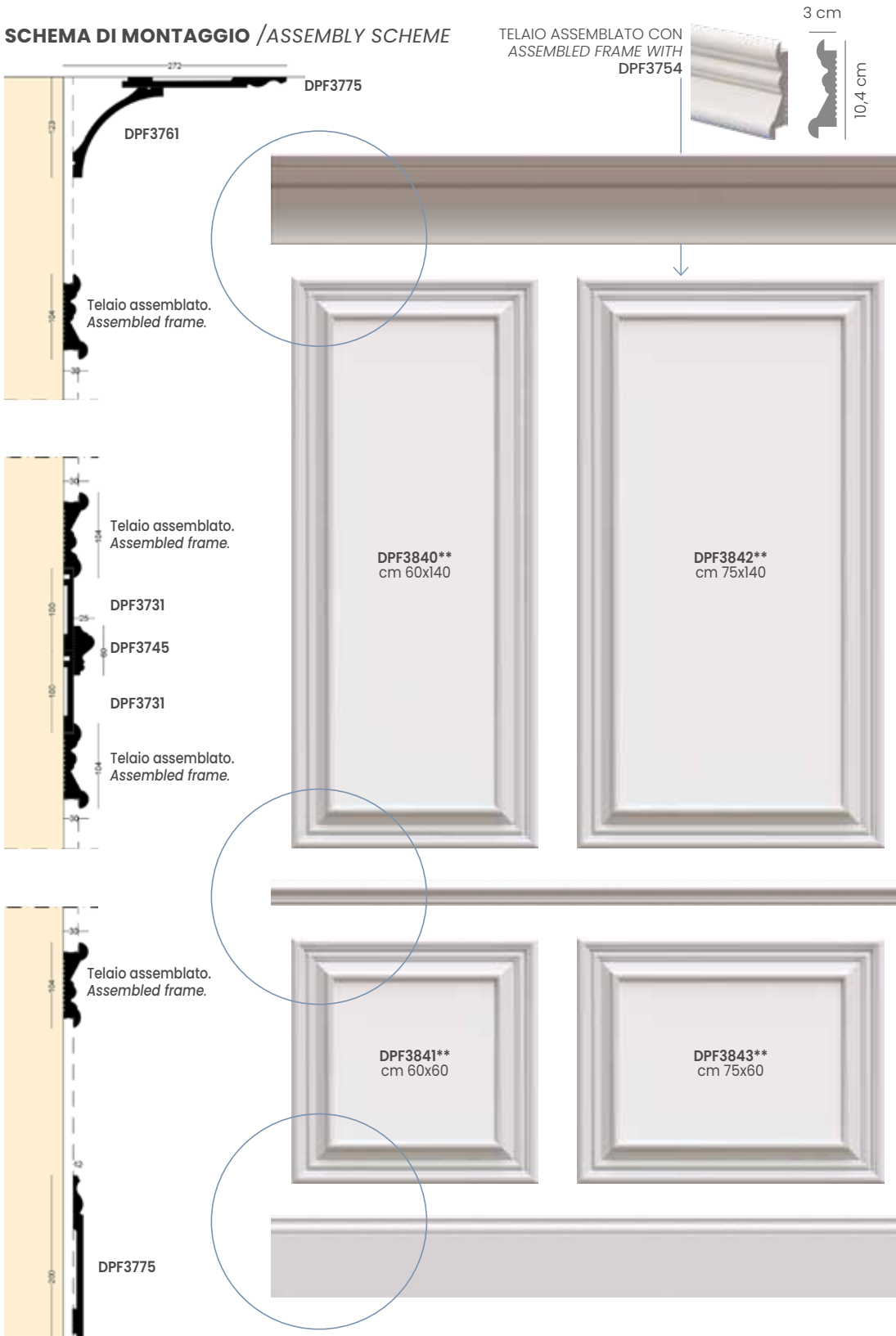

3 cm

10,4 cm



Collanti dedicati. Per quantità vedi listino.
Dedicated glues. For quantity see price list.
COL3589-COL3590
COL3591 (sigillante / sealant)

Vedi pagine
collanti
See gluing pages
176 - 177



FACILE INSTALLAZIONE
EASY INSTALLATION



VERNICIABILE
PAINTABLE



IMPERMEABILE
WATERPROOF

Boiserie

- 01 DPF3769 Battiscopa / Skirting boards - Pag. 103
- 02 DPF3849* Telaio pretagliato / Pre-cut frame - Pag. 28
- 03 DPF3853* Telaio pretagliato / Pre-cut frame - Pag. 30
- 04 DPF3776 Marcapiano / Skirting boards - Pag. 35
- 05 DPF3848* Telaio pretagliato / Pre-cut frame - Pag. 28
- 06 DPF3852* Telaio pretagliato / Pre-cut frame - Pag. 30
- 07 DPF3817 Cornice / Frame - Pag. 74
- 08 DPF3740 Cornice LED / LED frame - Pag. 86
- 09 DPF3787 Sguscio / Covering element - Pag. 90
- 10 DPF3818 Cornice soffitto / Ceiling frame - Pag. 74



Video tutorial.

 Collanti dedicati. Per quantità vedi listino.
Dedicated glues. For quantity see price list.
COL3589 - COL3590
COL3591 (sigillante / sealant)

Vedi pagine collanti
See gluing pages
176 - 177



FACILE INSTALLAZIONE
EASY INSTALLATION



VERNICIABILE
PAINTABLE



IMPERMEABILE
WATERPROOF





Boiserie



01 DPF3737 Battiscopa LED / LED Skirting boards - Pag. 96

02 DPF3933 Zoccolo / Plinth - Pag. 82

03 DPF3823 Cornice porta / Door frame - Pag. 78

04 DPF3913** Telaio assemblato / Assembled frame - Pag. 25

05 DPF3916** Telaio pretagliato / Pre-cut frame - Pag. 25

06 DPF3934 Tozzetto / Terminal - Pag. 82

07 DPF3746 Cornice Boiserie / Boiserie Frame - Pag. 37

08 DPF3738 Cornice LED / LED frame - Pag. 88

RESINA / RESIN

 Collanti dedicati. Per quantità vedi listino.
Dedicated glues. For quantity see price list.
COL3589-COL3590
COL3591 (sigillante / sealant)

Vedi pagine
collanti
See gluing pages
176 - 177



FACILE INSTALLAZIONE
EASY INSTALLATION



VERNICIABILE
PAINTABLE



IMPERMEABILE
WATERPROOF



Telai assemblati.
Assembled frames.

- DPF3910 **** cm 30X45 telaio assemblato / *assembled frame*
- DPF3911 **** cm 45X45 telaio assemblato / *assembled frame*
- DPF3912 **** cm 60X45 telaio assemblato / *assembled frame*
- DPF3913 **** cm 75X45 telaio assemblato / *assembled frame*

- DPF3914 *** cm 90X45 telaio pretagliato / *pre-cut frame*
- DPF3915 *** cm 105X45 telaio pretagliato / *pre-cut frame*
- DPF3916 *** cm 120X45 telaio pretagliato / *pre-cut frame*
- DPF3917 *** cm 135X45 telaio pretagliato / *pre-cut frame*



TELAIO ASSEMBLATO / *ASSEMBLED FRAME*



DPF3910**
cm 30x45



DPF3911**
cm 45x45



DPF3912**
cm 60x45



DPF3913**
cm 75x45

TELAIO PRETAGLIATO / *PRE-CUT FRAME*



DPF3914*
cm 90x45



DPF3915*
cm 105x45



DPF3916*
cm 120x45



DPF3917*
cm 135x45

Boiserie

DPF3918 ** cm 35X35 telaio assemblato / *assembled frame*

DPF3919 ** cm 35X50 telaio assemblato / *assembled frame*

DPF3920 ** cm 70X50 telaio assemblato / *assembled frame*

DPF3921 * cm 100X35 telaio pretagliato / *pre-cut frame*

DPF3922 * cm 125X35 telaio pretagliato / *pre-cut frame*

DPF3923 * cm 150X35 telaio pretagliato / *pre-cut frame*

TELAIO CON
FRAME WITH
DPF3735



TELAIO ASSEMBLATO / *ASSEMBLED FRAME*



DPF3918**
cm 35x35



DPF3919**
cm 50x35



DPF3920**
cm 70x35

TELAIO PRETAGLIATO / *PRE-CUT FRAME*



DPF3921*
cm 100x35



DPF3922*
cm 125x35



DPF3923*
cm 150x35

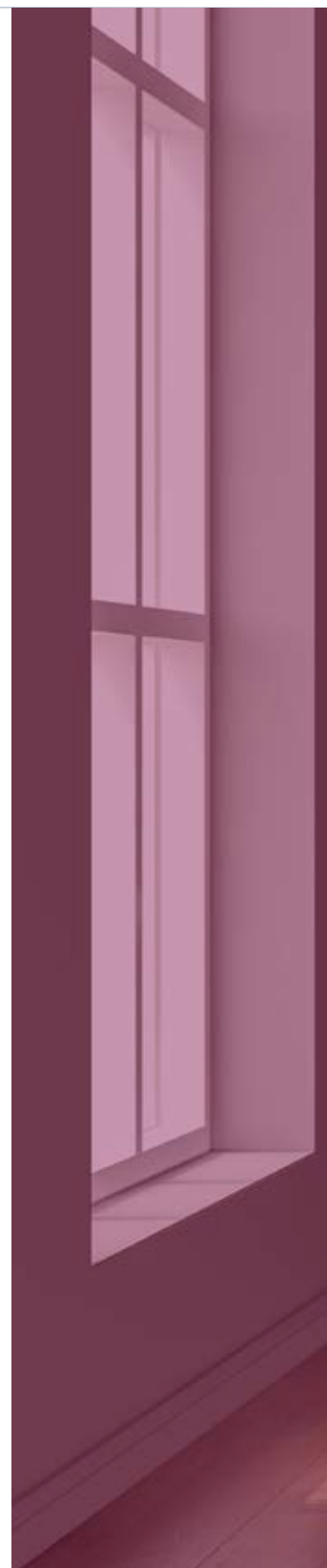



01 DPF3768 Battiscopa / Skirting boards - Pag. 99

02 DPF3920** Telaio assemblato / Assembled frame - Pag. 26

03 DPF3735 Cornice Boiserie / Boiserie frame - Pag. 37

04 DPF3734 Marcapiano / String course - Pag. 34

05 DPF3921* Telaio pretagliato / Pre-cut frame - Pag. 26

06 DPF3918** Telaio assemblato / Assembled frame - Pag. 26



Collanti dedicati. Per quantità vedi listino.
Dedicated glues. For quantity see price list.
COL3589-COL3590
COL3591 (sigillante / sealant)

Vedi pagine
collanti
See gluing pages
176 - 177



FACILE INSTALLAZIONE
EASY INSTALLATION



VERNICIABILE
PAINTABLE



IMPERMEABILE
WATERPROOF



Telai pretagliati.
Pre-cut frames.

Boiserie

DPF3846 * cm 50x160 telaio pretagliato / pre-cut frame

DPF3847 * cm 50x80 telaio pretagliato / pre-cut frame

DPF3848 * cm 65x160 telaio pretagliato / pre-cut frame

DPF3849 * cm 65x80 telaio pretagliato / pre-cut frame



SCHEMA DI MONTAGGIO / ASSEMBLY SCHEME

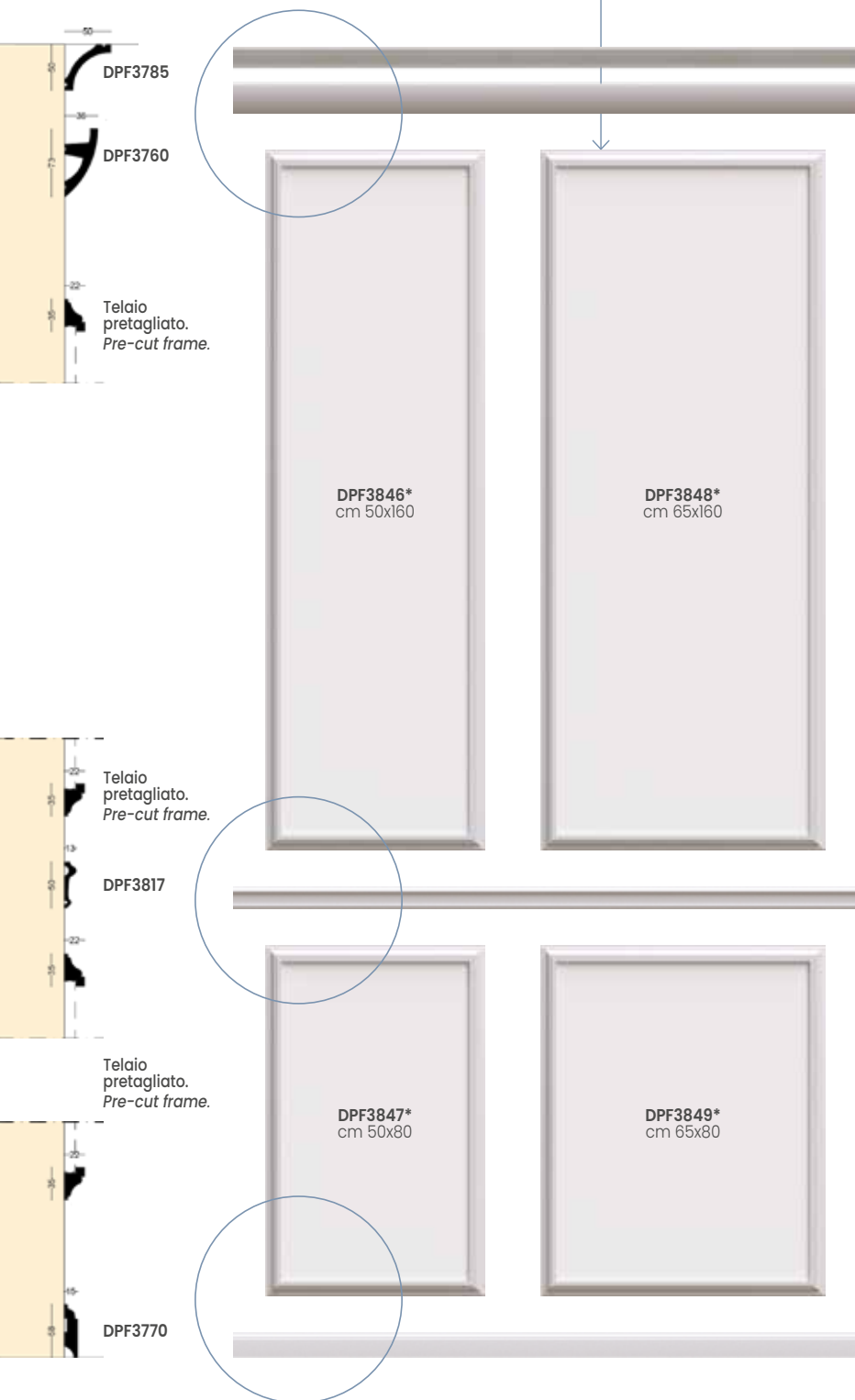

- 01 DPF3770 Battiscopa / Skirting boards - Pag. 103
- 02 DPF3930 Zoccolo / Plinth - Pag. 82
- 03 DPF3788 Lesena / Pilaster - Pag. 78
- 04 DPF3847* Telaio pretagliato / Pre-cut frame - Pag. 28
- 05 DPF3920** Telaio assemblato / Assembled frame - Pag. 26



06 DPF3782 Marcapiano / Skirting boards - Pag. 35

07 DPF3846* Telaio pretaglialto / Pre-cut frame - Pag. 28

08 DPF3921* Telaio pretaglialto / Pre-cut frame - Pag. 26

09 DPF3935 Tozzetto / Terminal - Pag. 82

10 DPF3756 Cornice Boiserie / Boiserie Frame - Pag. 37

11 DPF3760 Cornice LED / LED frame - Pag. 86

12 DPF3785 Sguscio / Coving element - Pag. 91

13 DPF3776 Cornice soffitto / Ceiling frame - Pag. 75

14 DPF3940** Telaio assemblato / Assembled frame - Pag. 76

15 DPF3941** Telaio assemblato / Assembled frame - Pag. 76



Coordinati cornici e cassettonati.
Coordinated frame and coving elements.



Collanti dedicati. Per quantità vedi listino.
Dedicated glues. For quantity see price list.
COL3589-COL3590
COL3591 (sigillante / sealant)

Vedi pagine collanti
See gluing pages
176 - 177



FACILE INSTALLAZIONE
EASY INSTALLATION



VERNICIABILE
PAINTABLE



IMPERMEABILE
WATERPROOF

RESINA / RESIN

teykos

Boiserie

DPF3850 * cm 80X160 telaio pretagliato / *pre-cut frame*

DPF3851 * cm 80X80 telaio pretagliato / *pre-cut frame*

DPF3852 * cm 95X160 telaio pretagliato / *pre-cut frame*

DPF3853 * cm 95X80 telaio pretagliato / *pre-cut frame*



SCHEMA DI MONTAGGIO ASSEMBLY SCHEME

TELAIO PRETAGLIATO CON
PRE-CUT FRAME WITH
DPF3756

2,2 cm

3,5 cm

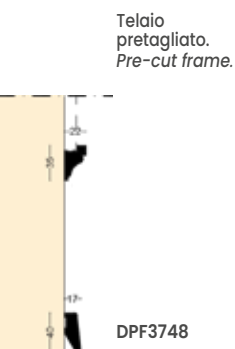
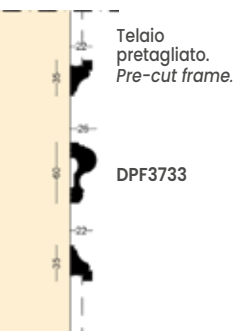
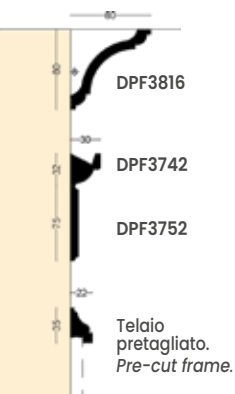

Collanti dedicati. Per quantità vedi listino.
Dedicated glues. For quantity see price list.
COL3589-COL3590
COL3591 (sigillante / sealant)

Vedi pagine
collanti
See gluing pages
176 - 177



FACILE INSTALLAZIONE
EASY INSTALLATION



VERNICIABILE
PAINTABLE



IMPERMEABILE
WATERPROOF



- 01 DPF3748 Battiscopa / Skirting boards - Pag. 100
- 02 DPF3847* Telaio pretagliato / Pre-cut frame - Pag. 28
- 03 DPF3853* Telaio pretagliato / Pre-cut frame - Pag. 30
- 04 DPF3733 Marcapiano / Skirting boards - Pag. 34
- 05 DPF3846* Telaio pretagliato / Pre-cut frame - Pag. 28
- 06 DPF3852* Telaio pretagliato / Pre-cut frame - Pag. 30
- 07 DPF3756 Cornice Boiserie / Boiserie Frame - Pag. 37
- 08 DPF3752 Cornice / Frame - Pag. 74
- 09 DPF3742 Cornice LED / LED frame - Pag. 88
- 10 DPF3816 Sguscio / Coving element - Pag. 91
- 11 DPF3746 Cornice soffitto / Ceiling frame - Pag. 75



Coordinati cornici LED.
Coordinated LED frames.

Boiserie

- 01 DPF3749 Battiscopa LED / LED Skirting boards - Pag. 96
- 02 EWP3893 Rivestimento murale / Wall covering - Pag. 122
- 03 DPF3755 Marcapiano / Skirting boards - Pag. 34
- 04 DPF3846* Telaio pretagliato / Pre-cut frame - Pag. 28
- 05 DPF3817 Cornice / Frame - Pag. 74
- 06 DPF3780 Cornice / Frame - Pag. 103
- 07 DPF3786 Sguscio / Coving element - Pag. 91
- 08 DPF3818 Cornice soffitto / Ceiling frame - Pag. 75



 Collanti dedicati. Per quantità vedi listino.
Dedicated glues. For quantity see price list.
COL3589-COL3590
COL3591 (sigillante / sealant)

Vedi pagine collanti
See gluing pages
176 - 177



FACILE INSTALLAZIONE
EASY INSTALLATION



VERNICIABILE
PAINTABLE



IMPERMEABILE
WATERPROOF



05

06

08

07

06

02

04

03

02

01

Cornici Boiserie

BOISERIE FRAMES



 Collanti dedicati. Per quantità vedi listino.
Dedicated glues. For quantity see price list.
COL3589-COL3590
COL3591 (sigillante / sealant)

Vedi pagine
collanti
See gluing pages
176 - 177



FACILE INSTALLAZIONE
EASY INSTALLATION



VERNICIABILE
PAINTABLE



IMPERMEABILE
WATERPROOF

teykos

2,6 cm



DPF3764



1,3 cm



DPF3782



2,5 cm



DPF3745



0,8 cm



DPF3776



Cornici Boiserie



 Collanti dedicati. Per quantità vedi listino.
Dedicated glues. For quantity see price list.
COL3589-COL3590
COL3591 (sigillante / sealant)

Vedi pagine
collanti
See gluing pages
176 - 177



FACILE INSTALLAZIONE
EASY INSTALLATION



VERNICIABILE
PAINTABLE



IMPERMEABILE
WATERPROOF

BOISERIE FRAMES



Boiserie

DPF3856 * cm 50x160 telaio pretagliato / pre-cut frame

DPF3857 * cm 50x80 telaio pretagliato / pre-cut frame

DPF3858 * cm 65x160 telaio pretagliato / pre-cut frame

DPF3859 * cm 65x80 telaio pretagliato / pre-cut frame

SCHEMA DI MONTAGGIO / ASSEMBLY SCHEME

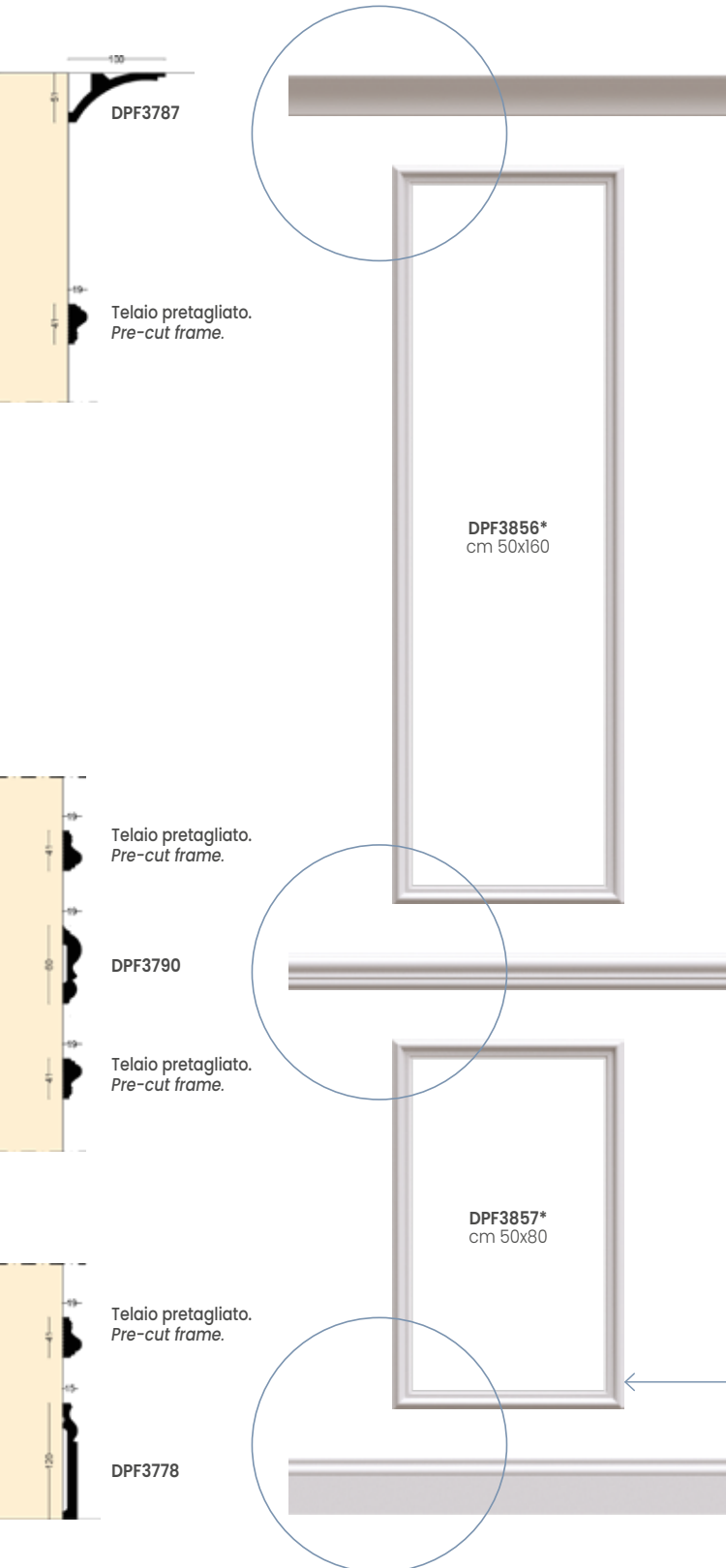

TELAIO PRETAGLIATO CON
PRE-CUT FRAME WITH
DPF3746

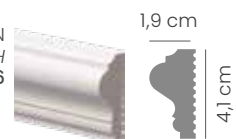

Coordinati sgusci.
Coordinated
coving elements.

Collanti dedicati. Per quantità vedi listino.
Dedicated glues. For quantity see price list.
COL3589-COL3590
COL3591 (sigillante / sealant)

Vedi pagine
collanti
See gluing pages
176 - 177



FACILE INSTALLAZIONE
EASY INSTALLATION



VERNICIABILE
PAINTABLE



IMPERMEABILE
WATERPROOF



DPF3858*
cm 65x160



DPF3859*
cm 65x80



- 01 DPF3778 Battiscopa / Skirting boards - Pag. 102
- 02 DPF3857* Telaio pretagliato / Pre-cut frame - Pag. 38
- 03 DPF3867* Telaio pretagliato / Pre-cut frame - Pag. 43
- 04 DPF3861* Telaio pretagliato / Pre-cut frame - Pag. 40
- 05 DPF3790 Marcapiano / Skirting boards - Pag. 34
- 06 DPF3856* Telaio pretagliato / Pre-cut frame - Pag. 38
- 07 DPF3866* Telaio pretagliato / Pre-cut frame - Pag. 43
- 08 DPF3860* Telaio pretagliato / Pre-cut frame - Pag. 40
- 09 DPF3787 Sguscio / Coving element - Pag. 90
- 10 DPF3746 Cornice soffitto / Ceiling frame - Pag. 75

Boiserie

DPF3860 * cm 80x160 telaio pretagliato / pre-cut frame

DPF3861 * cm 80x80 telaio pretagliato / pre-cut frame

SCHEMA DI MONTAGGIO ASSEMBLY SCHEME

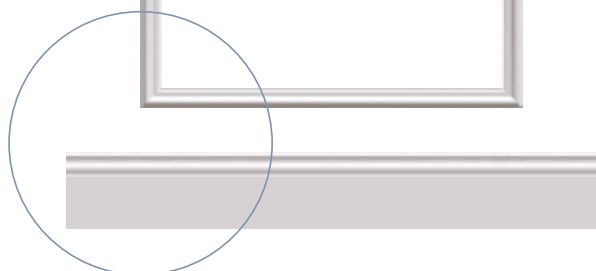
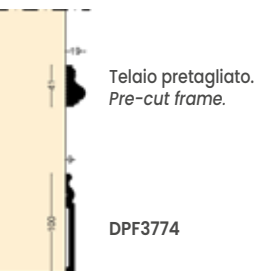
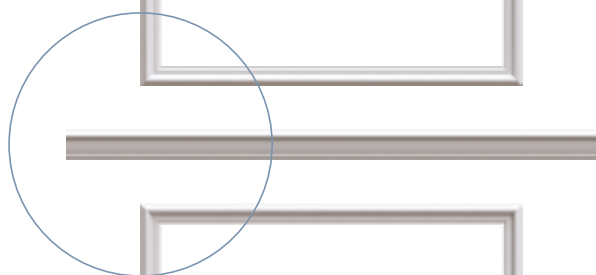
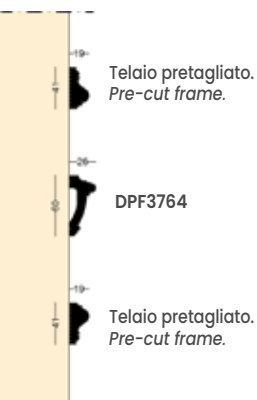
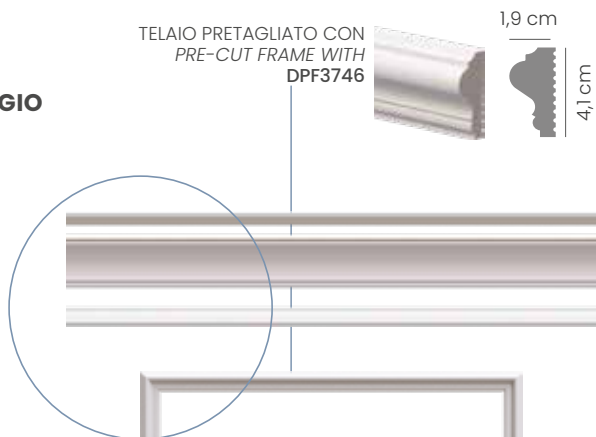
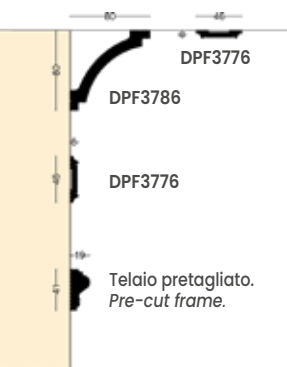

Coordinati cornici Boiserie.
Coordinated Boiserie frames.



01 DPF3774 Battiscopa / Skirting boards - Pag. 102

02 DPF3861* Telaio pretagliato / Pre-cut frame - Pag. 40

03 DPF3764 Marcapiano / Skirting boards - Pag. 35

04 DPF3860* Telaio pretagliato / Pre-cut frame - Pag. 40

05 DPF3776 Cornice / Boiserie - Pag. 75

06 DPF3786 Sguscio / Coving element - Pag. 91

07 DPF3746 Cornice soffitto / Ceiling frame - Pag. 75

 Collanti dedicati. Per quantità vedi listino.
Dedicated glues. For quantity see price list.
COL3589-COL3590
COL3591 (sigillante / sealant)

Vedi pagine
collanti
See gluing pages
176 - 177



FACILE INSTALLAZIONE
EASY INSTALLATION



VERNICIABILE
PAINTABLE



IMPERMEABILE
WATERPROOF

Boiserie

DPF3862 * cm 95x160 telaio pretagliato / *pre-cut frame*

DPF3863 * cm 95x80 telaio pretagliato / *pre-cut frame*

DPF3864 * cm 110x160 telaio pretagliato / *pre-cut frame*

DPF3865 * cm 110x80 telaio pretagliato / *pre-cut frame*

SCHEMA DI MONTAGGIO / ASSEMBLY SCHEME

TELAIO PRETAGLIATO CON
PRE-CUT FRAME WITH
DPF3746

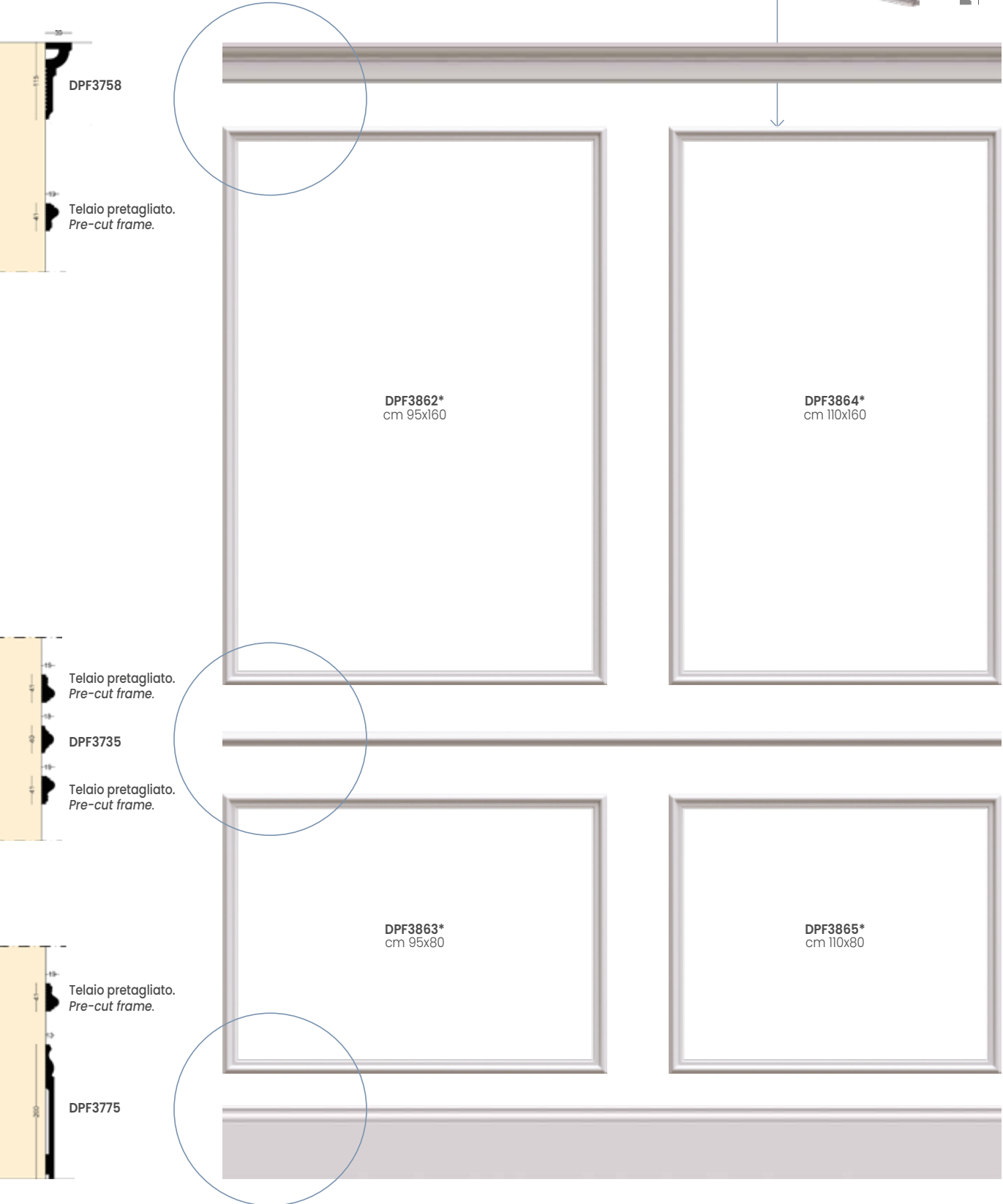
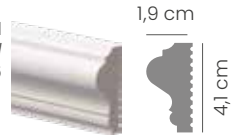

DPF3758

Telaio pretagliato.
Pre-cut frame.

DPF3862*
cm 95x160

DPF3864*
cm 110x160

Telaio pretagliato.
Pre-cut frame.

DPF3735

Telaio pretagliato.
Pre-cut frame.

DPF3863*
cm 95x80

DPF3865*
cm 110x80

Telaio pretagliato.
Pre-cut frame.

DPF3775

Collanti dedicati. Per quantità vedi listino.
Dedicated glues. For quantity see price list.
COL3589-COL3590
COL3591 (sigillante / *sealant*)

Vedi pagine
collanti
See gluing pages
176 - 177



FACILE INSTALLAZIONE
EASY INSTALLATION



VERNICIABILE
PAINTABLE



IMPERMEABILE
WATERPROOF

RESINA / *RESIN*



- 06 DPF3858* Telaio pretagliato / Pre-cut frame - Pag. 39
- 07 DPF3860* Telaio pretagliato / Pre-cut frame - Pag. 40
- 08 DPF3758 Cornice / Frame - Pag. 74
- 09 DPF3746 Cornice soffitto / Ceiling frame - Pag. 75



DPF3866*
cm 135x160



DPF3867*
cm 135x80



- 01 DPF3775 Battiscopa / Skirting boards - Pag. 102
- 02 DPF3859* Telaio pretagliato / Pre-cut frame - Pag. 39
- 03 DPF3861* Telaio pretagliato / Pre-cut frame - Pag. 40
- 04 DPF3735 Marcapiano / Skirting boards - Pag. 75
- 05 DPF3928 Decoro / Decor - Pag. 66





Boiserie

DPF3868 * cm 25x135 telaio pretagliato / pre-cut frame

DPF3869 * cm 25x55 telaio pretagliato / pre-cut frame

TELAIO PRETAGLIATO CON
PRE-CUT FRAME WITH
DPF3736

1,2 cm
2,4 cm

SCHEMA DI MONTAGGIO ASSEMBLY SCHEME

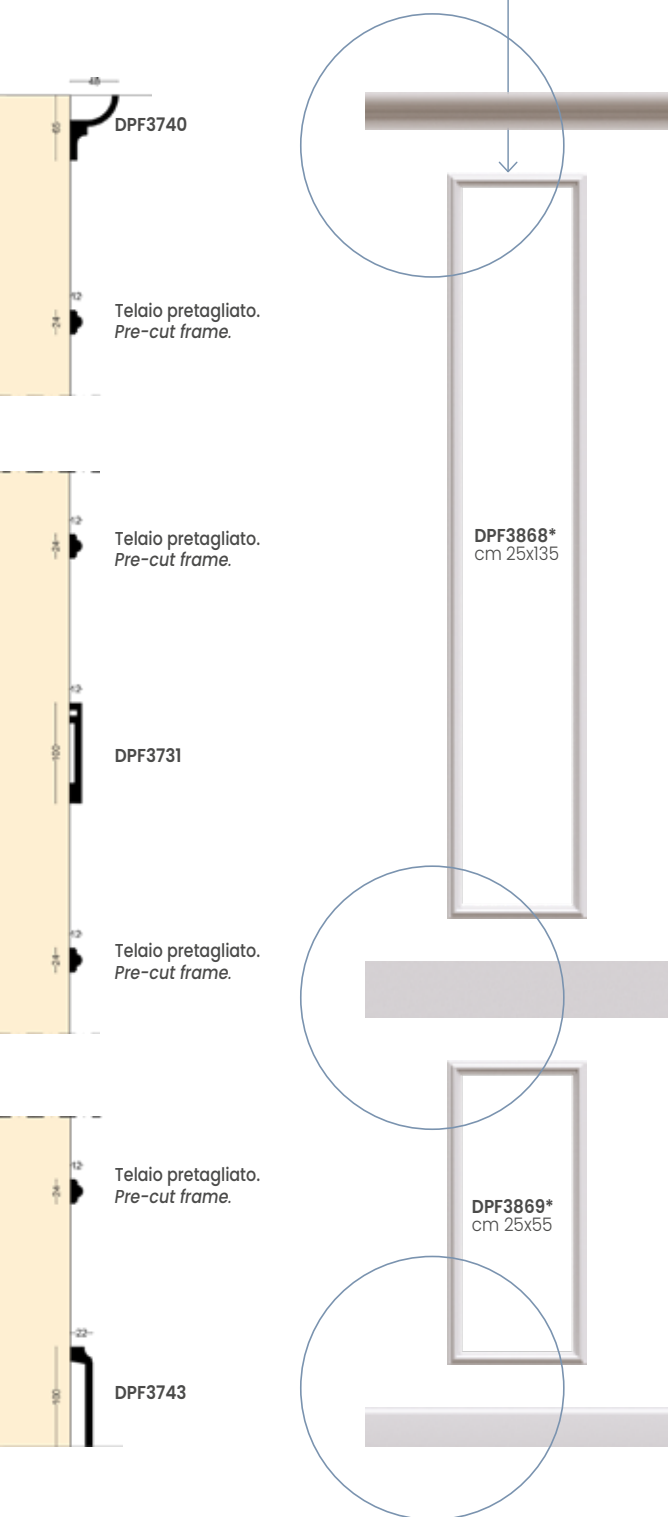

- 01 DPF3743 Coprimarmo / Marble cover - Pag. 108
- 02 DPF3877* Telaio pretagliato / Pre-cut frame - Pag. 50
- 03 DPF3869* Telaio pretagliato / Pre-cut frame - Pag. 46
- 04 DPF3871* Telaio pretagliato / Pre-cut frame - Pag. 48



05 DPF3731 Marcapiano / Skirting boards - Pag. 34

06 DPF3876* Telaio pretagliato / Pre-cut frame - Pag. 50

07 DPF3868* Telaio pretagliato / Pre-cut frame - Pag. 46

08 DPF3870* Telaio pretagliato / Pre-cut frame - Pag. 48

09 DPF3740 Cornice LED / LED frame - Pag. 86

10 DPF3818 Cornice soffitto / Ceiling frame - Pag. 75

11 DPF3819 Centina / Curve - Pag. 65



Coordinati
coprimarmo e parasigoli.
Coordinated
marble cover and coated
edge protectors.

 Collanti dedicati. Per quantità vedi listino.
Dedicated glues. For quantity see price list.
COL3589-COL3590
COL3591 (sigillante / sealant)

Vedi pagine
collanti
See gluing pages
176 - 177



FACILE INSTALLAZIONE
EASY INSTALLATION



VERNICIABILE
PAINTABLE



IMPERMEABILE
WATERPROOF

Boiserie

DPF3870 * cm 40x135 telaio pretagliato / *pre-cut frame*

DPF3871 * cm 40x55 telaio pretagliato / *pre-cut frame*

DPF3872 * cm 55x135 telaio pretagliato / *pre-cut frame*

DPF3873 * cm 55x55 telaio pretagliato / *pre-cut frame*

DPF3874 * cm 70x135 telaio pretagliato / *pre-cut frame*

DPF3875 * cm 70x55 telaio pretagliato / *pre-cut frame*

SCHEMA DI MONTAGGIO / ASSEMBLY SCHEME

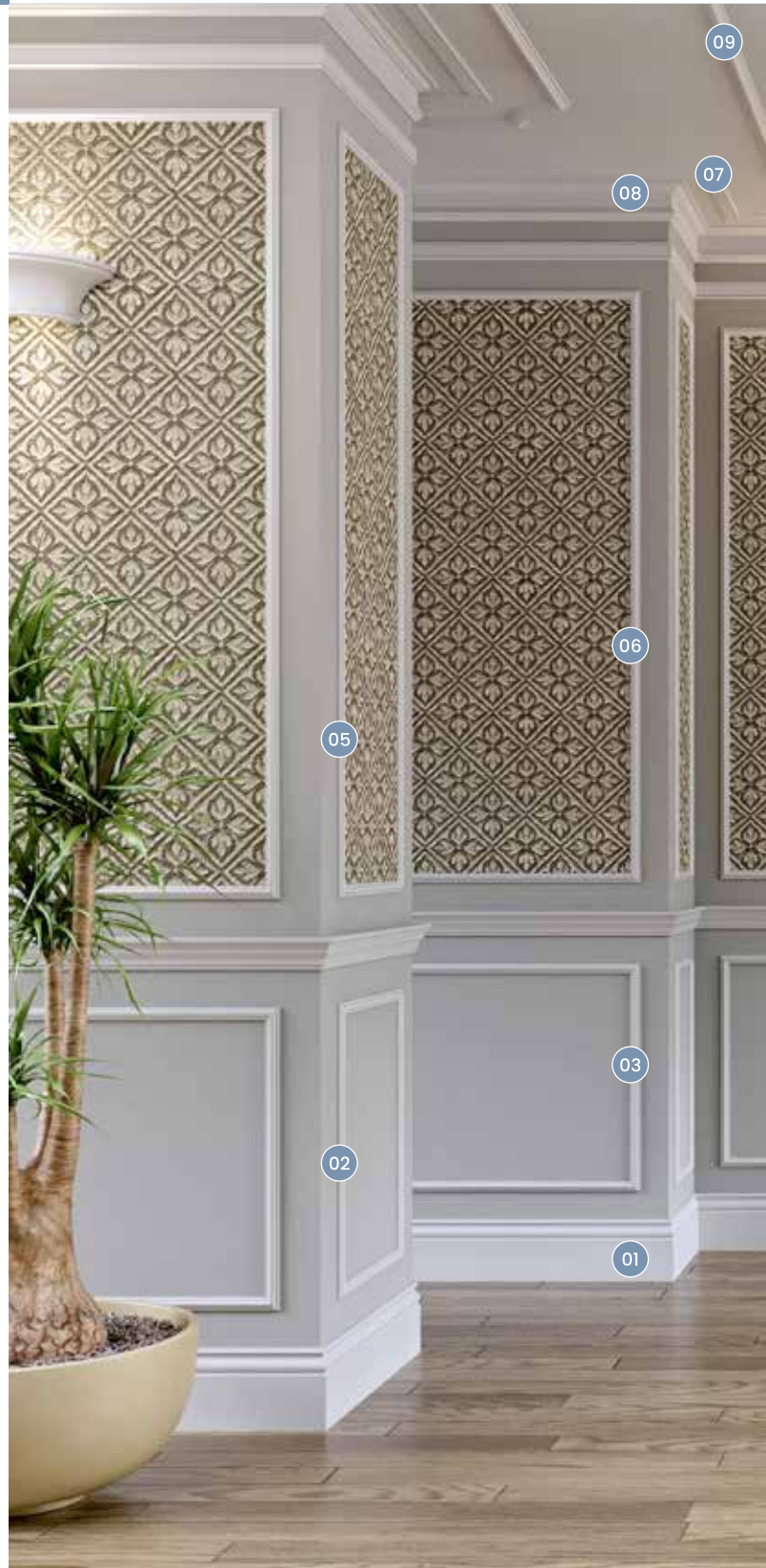
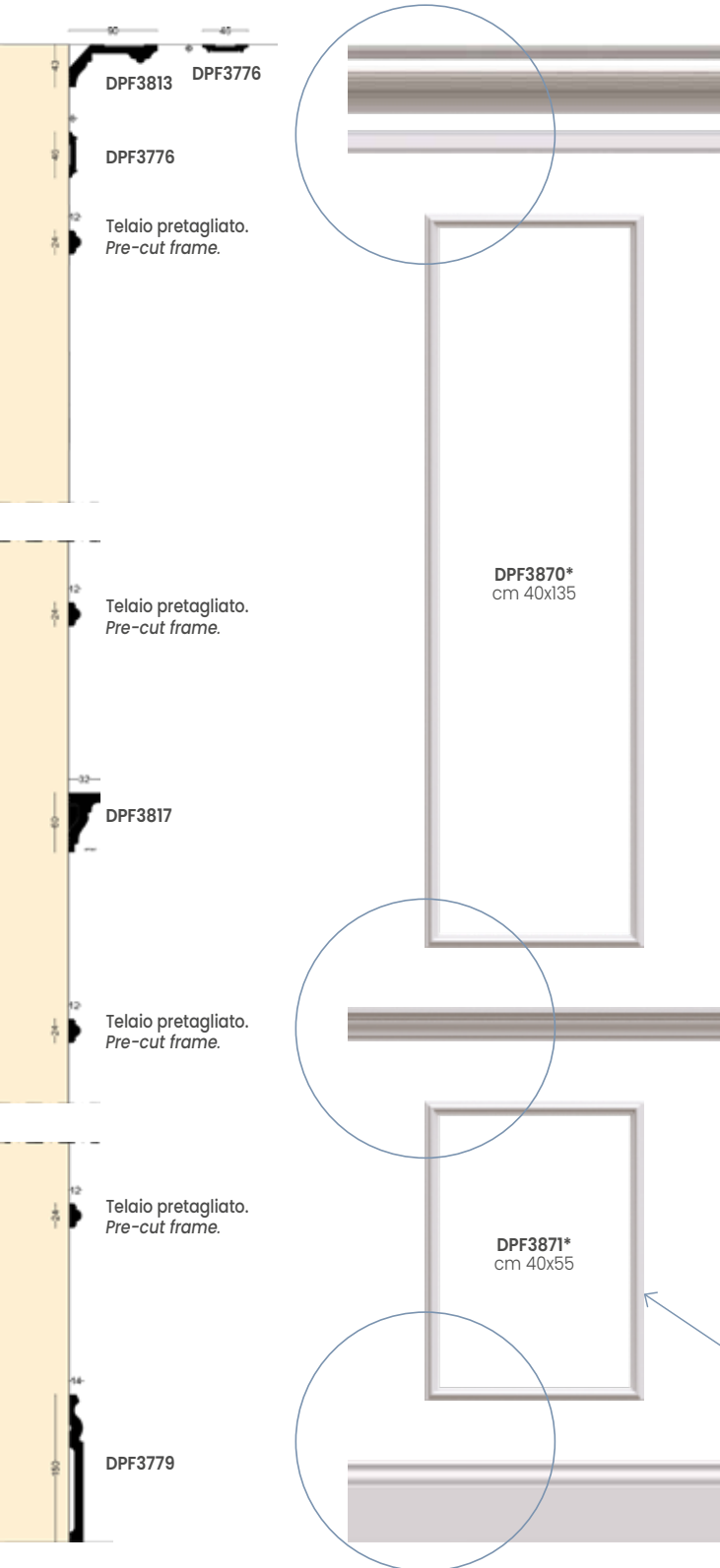

TELAIO PRETAGLIATO CON
PRE-CUT FRAME WITH
DPF3736



Collanti dedicati. Per quantità vedi listino.
Dedicated glues. For quantity see price list.
COL3589-COL3590
COL3591 (sigillante / sealant)

Vedi pagine
collanti
See gluing pages
176 - 177



FACILE INSTALLAZIONE
EASY INSTALLATION



VERNICIABILE
PAINTABLE



IMPERMEABILE
WATERPROOF



- 06 DPF3876* Telaio pretagliato / Pre-cut frame - Pag. 50
- 07 DPF3776 Cornice / Frame - Pag. 75
- 08 DPF3813 Sguscio / Coving element - Pag. 91
- 09 DPF3818 Cornice soffitto / Ceiling frame - Pag. 75
- 10 DPF3819 Centina / Curve - Pag. 156



- 01 DPF3779 Battiscopa / Skirting boards - Pag. 102
- 02 DPF3871* Telaio pretagliato / Pre-cut frame - Pag. 48
- 03 DPF3877* Telaio pretagliato / Pre-cut frame - Pag. 50
- 04 DPF3817 Marcapiano / Skirting boards - Pag. 75
- 05 DPF3870** Telaio assemblato / Assembled frame - Pag. 48

Boiserie

DPF3876 * cm 85x135 telaio pretagliato / *pre-cut frame*

DPF3877 * cm 85x55 telaio pretagliato / *pre-cut frame*

DPF3878 * cm 100x135 telaio pretagliato / *pre-cut frame*

DPF3879 * cm 100x55 telaio pretagliato / *pre-cut frame*

SCHEMA DI MONTAGGIO / ASSEMBLY SCHEME

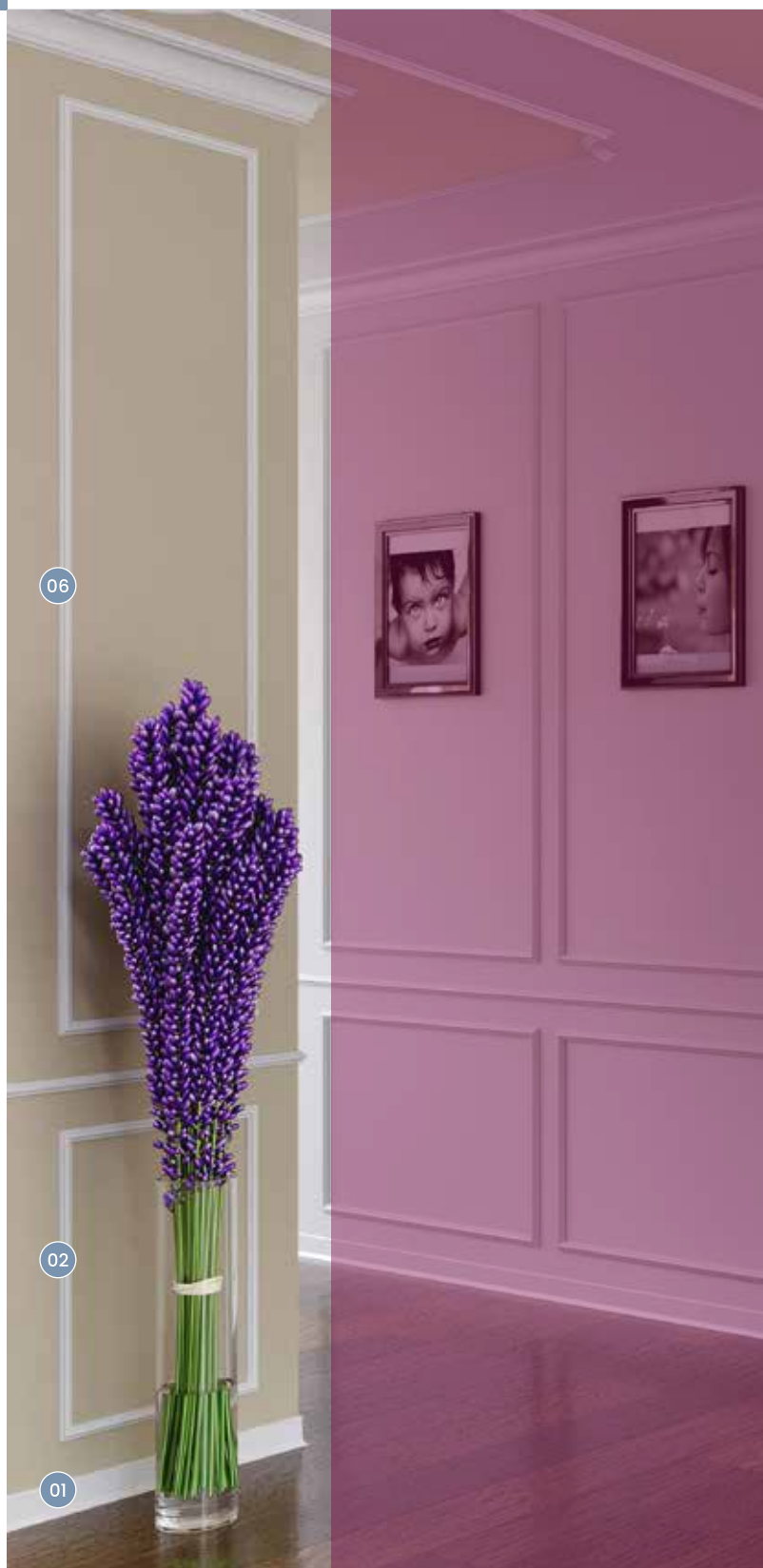
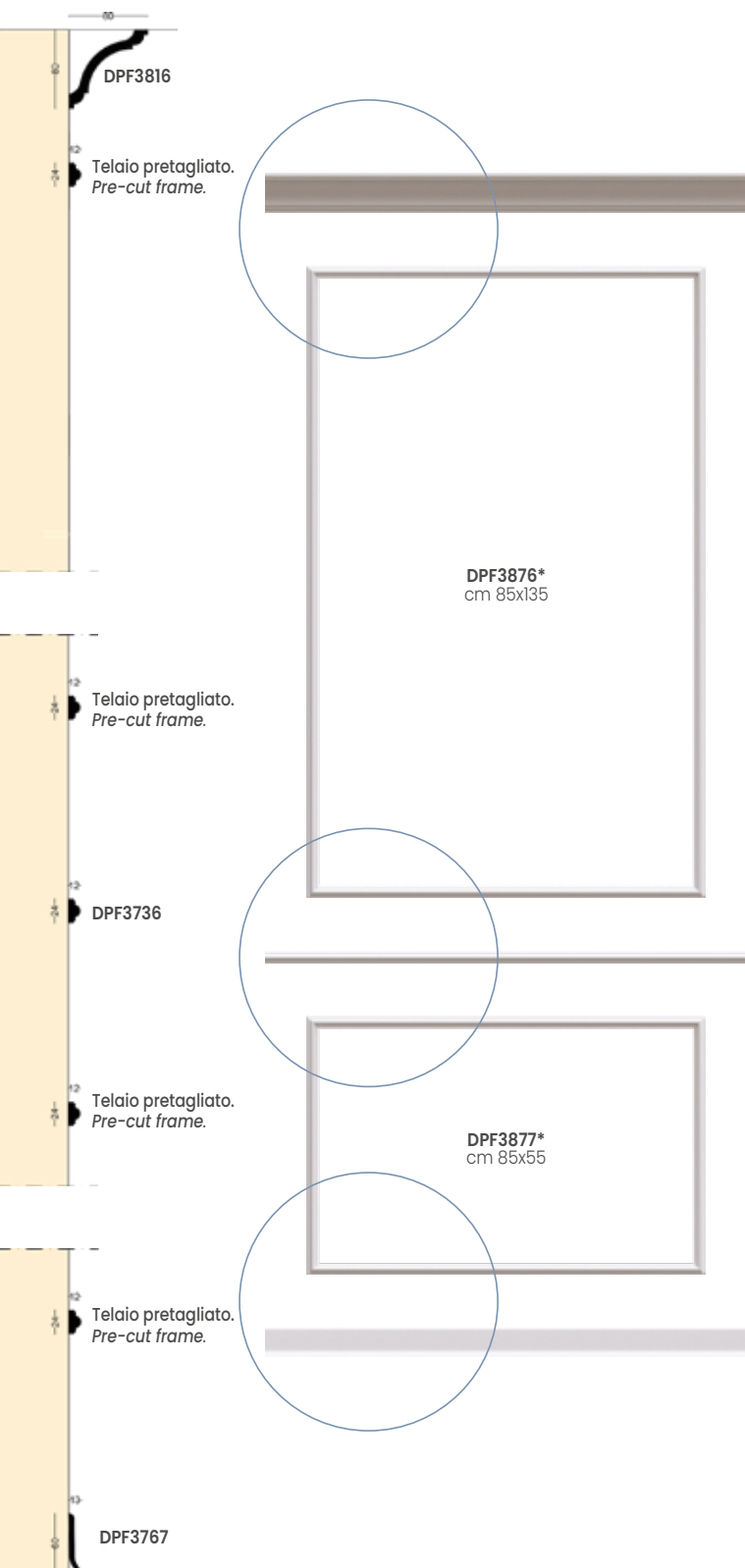

Collanti dedicati. Per quantità vedi listino.
Dedicated glues. For quantity see price list.
COL3589-COL3590
COL3591 (sigillante / *sealant*)

Vedi pagine
collanti
See gluing pages
176 - 177



FACILE INSTALLAZIONE
EASY INSTALLATION



VERNICIABILE
PAINABLE



IMPERMEABILE
WATERPROOF



10

11

09

08

07

03

04

05

TELAIO PRETAGLIATO CON
PRE-CUT FRAME WITH
DPF3736



1,2 cm
2,4 cm



DPF3878*
cm 110x135



DPF3879*
cm 110x55

- 01 DPF3767 Battiscopa / Skirting boards - Pag. 103
- 02 DPF3869* Telaio pretagliato / Pre-cut frame - Pag. 46
- 03 DPF3871* Telaio pretagliato / Pre-cut frame - Pag. 48
- 04 DPF3877* Telaio pretagliato / Pre-cut frame - Pag. 50
- 05 DPF3736 Marcapiano / Skirting boards - Pag. 37
- 06 DPF3868* Telaio pretagliato / Pre-cut frame - Pag. 46

- 07 DPF3870* Telaio pretagliato / Pre-cut frame - Pag. 48
- 08 DPF3876* Telaio pretagliato / Pre-cut frame - Pag. 50
- 09 DPF3816 Sguscio / Coving element - Pag. 91
- 10 DPF3818 Cornice soffitto / Ceiling frame - Pag. 75
- 11 DPF3819 Centina / Curve - Pag. 65

Boiserie



09 Sguscio composto / *Composed coving element*

09/A DPF3768 Cornice / *Frame - Pag. 99*

09/B DPF3783 Sguscio / *Coving element - Pag. 91*



Coordinati
lesene, liste da porta
e finestre.
*Coordinated
pilasters, door frames
and windows.*



Collanti dedicati. Per quantità vedi listino.
Dedicated glues. For quantity see price list.
COL3589-COL3590
COL3591 (sigillante / *sealant*)

Vedi pagine
collanti
See gluing pages
176 - 177



FACILE INSTALLAZIONE
EASY INSTALLATION



VERNICIABILE
PAINTABLE



IMPERMEABILE
WATERPROOF



01 DPF3768 Battiscopa / Skirting boards - Pag. 99

02 DPF3931 Zoccolo / Plinth - Pag. 82

03 DPF3773 Lesena / Pilaster - Pag. 78

04 DPF3853* Telaio pretagliato / Pre-cut frame - Pag. 30

05 DPF3746 Marcapiano / Skirting boards - Pag. 37

06 DPF3852* Telaio pretagliato / Pre-cut frame - Pag. 30

07 DPF3936 Tozzetto / Terminal - Pag. 82

08 DPF3756 Cornice Boiserie / Boiserie Frame - Pag. 37

09 DPF3768-DPF3783 Sguscio composto / Composed coving element - Pag. 99 - 91

10 DPF3746 Cornice soffitto / Ceiling frame - Pag. 74

● RESINA / RESIN

Boiserie

- DPF3856 *** cm 50x160 telaio pretagliato / *pre-cut frame*
- DPF3947 **** cm 30x140 telaio assemblato / *assembled frame*
- DPF3857 *** cm 50x80 telaio pretagliato / *pre-cut frame*
- DPF3948 **** cm 30x60 telaio assemblato / *assembled frame*
- DPF3866 *** cm 135x160 telaio pretagliato / *pre-cut frame*
- DPF3957 **** cm 115x140 telaio assemblato / *assembled frame*
- DPF3867 *** cm 135x80 telaio pretagliato / *pre-cut frame*
- DPF3958 **** cm 115x60 telaio assemblato / *assembled frame*

SCHEMA DI MONTAGGIO / ASSEMBLY SCHEME

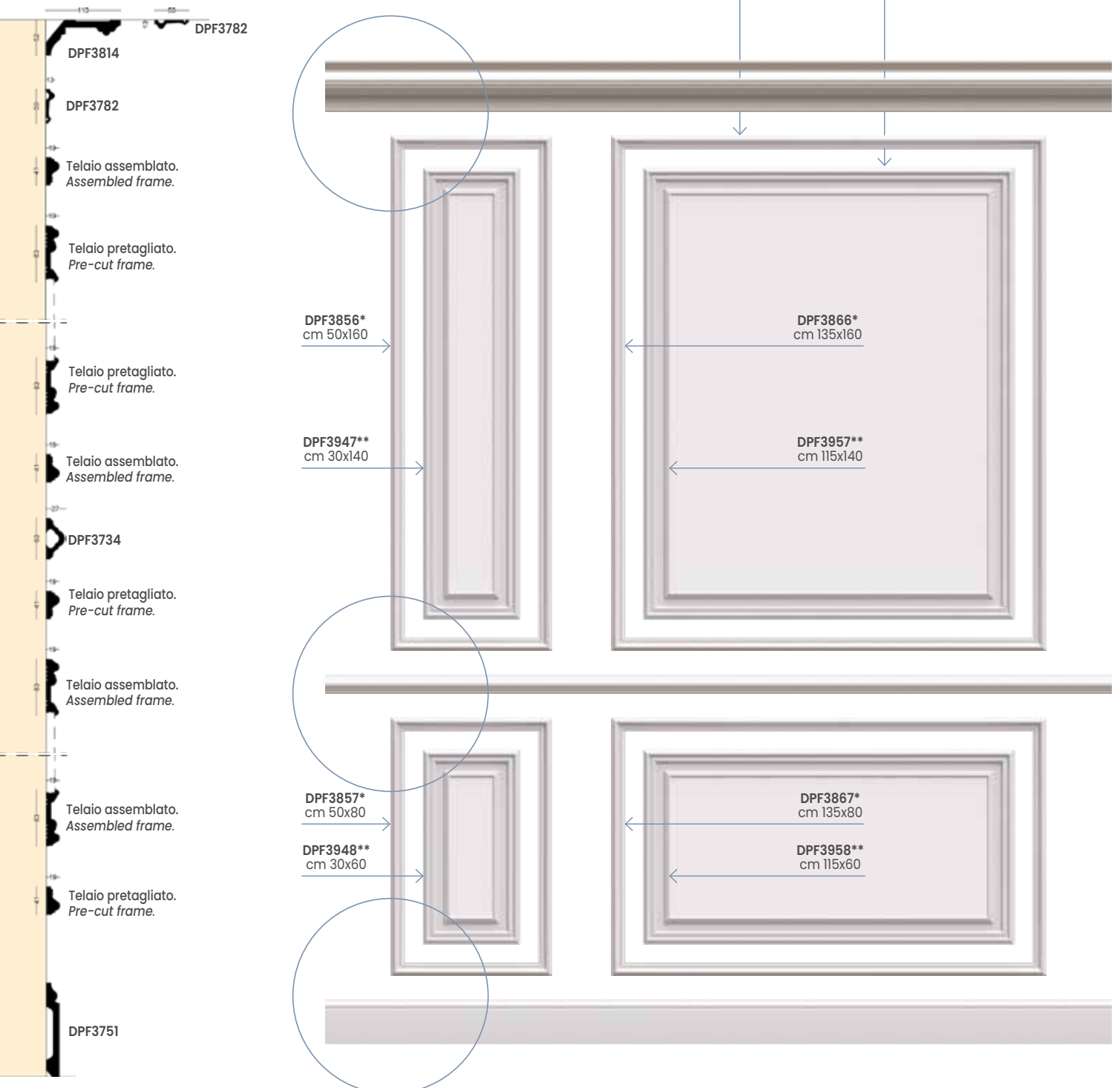

Collanti dedicati. Per quantità vedi listino. Dedicated glues. For quantity see price list. COL3589-COL3590 COL3591 (sigillante / sealant)

Vedi pagine collanti See gluing pages 176 - 177



FACILE INSTALLAZIONE EASY INSTALLATION



VERNICIABILE PAINTABLE



IMPERMEABILE WATERPROOF



01 DPF3751 Battiscopa / Skirting boards - Pag. 102

02 DPF3861* Telaio pretagliato / Pre-cut frame - Pag. 56

03 DPF3952** Telaio assemblato / Assembled frame - Pag. 56

04 DPF3865* Telaio pretagliato / Pre-cut frame - Pag. 60

05 DPF3956** Telaio assemblato / Assembled frame - Pag. 60

06 DPF3734 Marcapiano / Skirting boards - Pag. 34

07 DPF3860* Telaio pretagliato / Pre-cut frame - Pag. 56

08 DPF3951** Telaio assemblato / Assembled frame - Pag. 56

09 DPF3864* Telaio pretagliato / Pre-cut frame - Pag. 60

10 DPF3955** Telaio assemblato / Assembled frame - Pag. 60

11 DPF3782 Cornice / Frame - Pag. 75

12 DPF3814 Sguscio / Coving element - Pag. 90

Boiserie

- DPF3858 * cm 65x160 telaio pretagliato / *pre-cut frame*
- DPF3949 ** cm 45x140 telaio assemblato / *assembled frame*
- DPF3859 * cm 65x80 telaio pretagliato / *pre-cut frame*
- DPF3950 ** cm 45x60 telaio assemblato / *assembled frame*
- DPF3860 * cm 80x160 telaio pretagliato / *pre-cut frame*
- DPF3951 ** cm 60x140 telaio assemblato / *assembled frame*
- DPF3861 * cm 80x80 telaio pretagliato / *pre-cut frame*
- DPF3952 ** cm 60x60 telaio assemblato / *assembled frame*

TELAIO PRETAGLIATO CON
PRE-CUT FRAME WITH
DPF3746

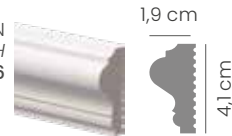

TELAIO ASSEMBLATO CON
ASSEMBLED FRAME WITH
DPF3755

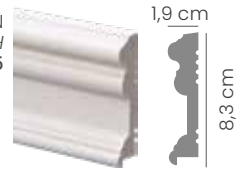

SCHEMA DI MONTAGGIO / ASSEMBLY SCHEME

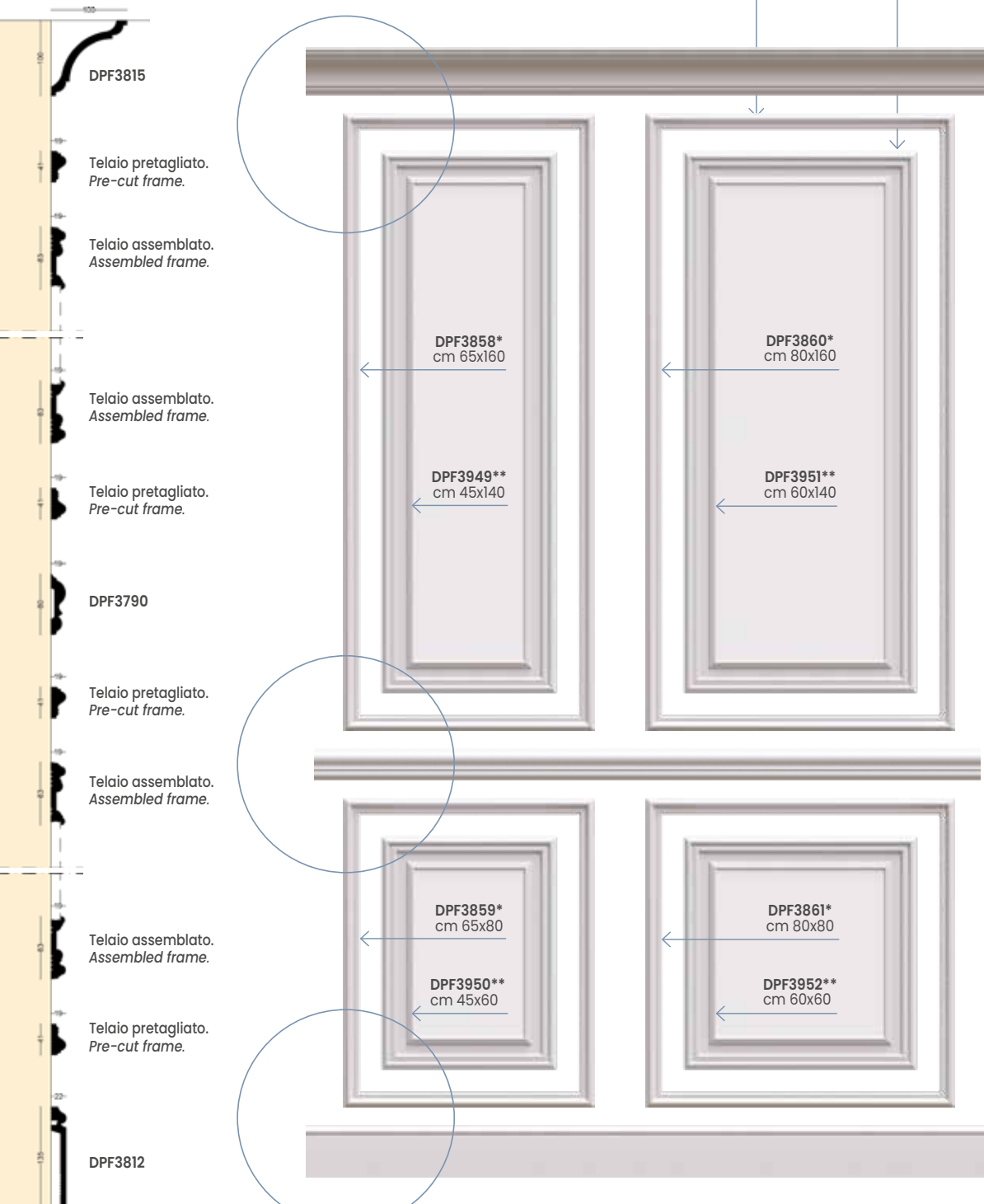

 Collanti dedicati. Per quantità vedi listino.
Dedicated glues. For quantity see price list.
COL3589-COL3590
COL3591 (sigillante / sealant)

Vedi pagine
collanti
See gluing pages
176 - 177



FACILE INSTALLAZIONE
EASY INSTALLATION



VERNICIABILE
PAINTABLE



IMPERMEABILE
WATERPROOF



01 DPF3812 Coprimarmo / Marble cover - Pag. 108

02 DPF3861* Telaio pretagliato / Pre-cut frame - Pag. 56

03 DPF3952** Telaio assemblato / Assembled frame - Pag. 56

04 DPF3865* Telaio pretagliato / Pre-cut frame - Pag. 60

05 DPF3956** Telaio assemblato / Assembled frame - Pag. 60

06 DPF3790 Marcapiano / Skirting boards - Pag. 34

07 DPF3860* Telaio pretagliato / Pre-cut frame - Pag. 56

08 DPF3951** Telaio assemblato / Assembled frame - Pag. 56

09 DPF3864* Telaio pretagliato / Pre-cut frame - Pag. 60

10 DPF3955** Telaio assemblato / Assembled frame - Pag. 60

11 DPF3815 Sguscio / Coving element - Pag. 90

12 DPF3746 Cornice soffitto / Ceiling frame - Pag. 75

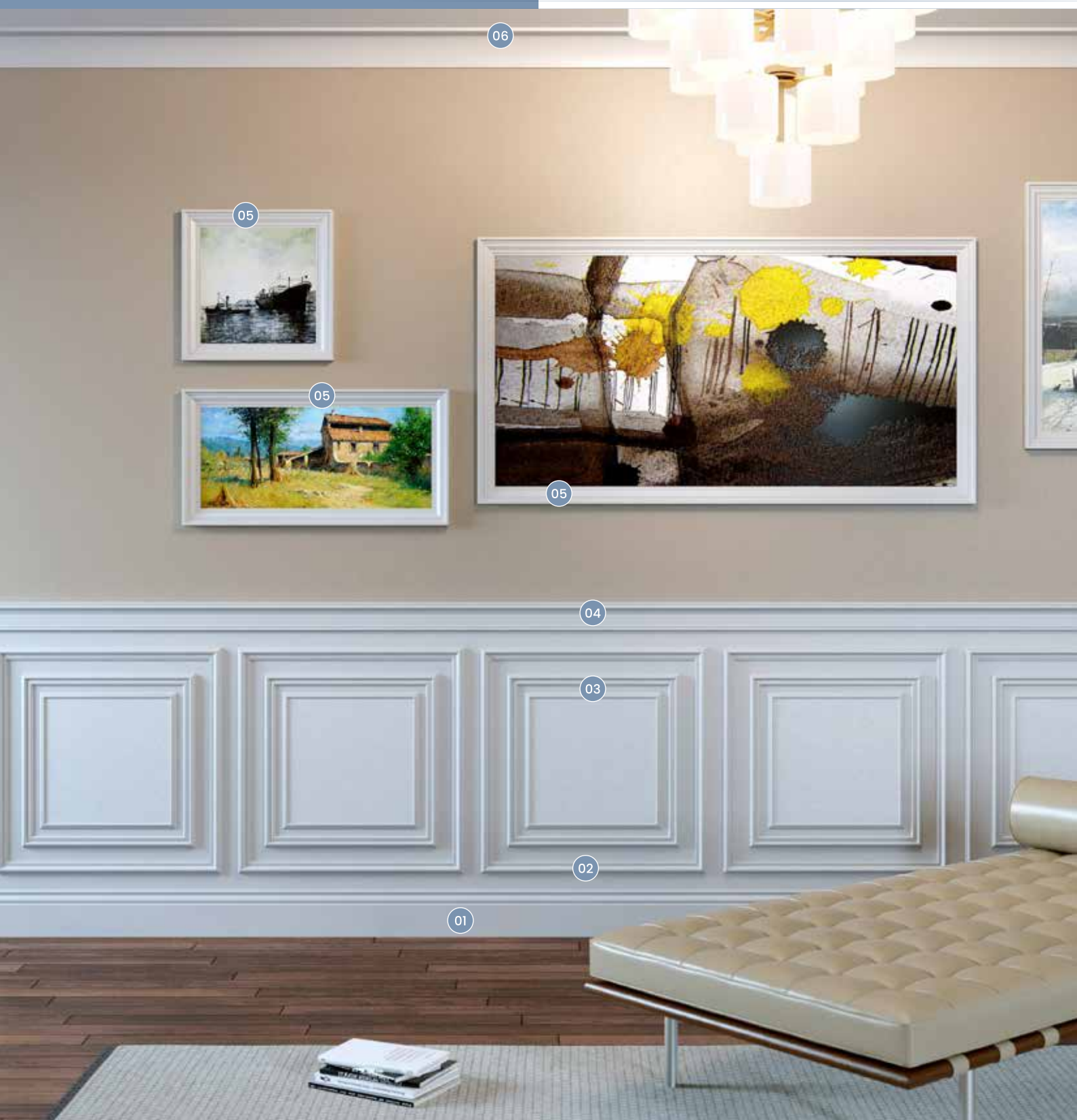

01 DPF3774 Battiscopa / Skirting boards - Pag. 102

02 DPF3861* Telaio pretagliato / Pre-cut frame - Pag. 57

03 DPF3952** Telaio assemblato / Assembled frame - Pag. 57

04 DPF3757 Marcapiano / Skirting boards - Pag. 74

05 DPF3817 Cornice / Frame - Pag. 74

06 DPF3761 Sguscio / Coving element - Pag. 90

 Collanti dedicati. Per quantità vedi listino.
Dedicated glues. For quantity see price list.
COL3589-COL3590
COL3591 (sigillante / sealant)

Vedi pagine
collanti
See gluing pages
176 - 177



FACILE INSTALLAZIONE
EASY INSTALLATION



VERNICIABILE
PAINTABLE



IMPERMEABILE
WATERPROOF



05

DPF3863 * cm 95x80 telaio pretagliato / *pre-cut frame*

DPF3954 ** cm 75x60 telaio assemblato / *assembled frame*



SCHEMA DI MONTAGGIO / ASSEMBLY SCHEME

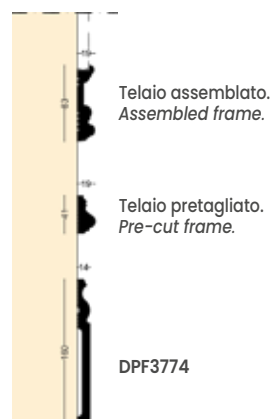
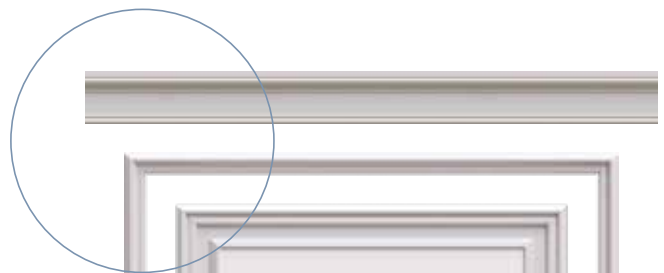
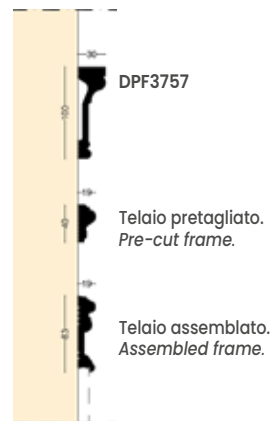
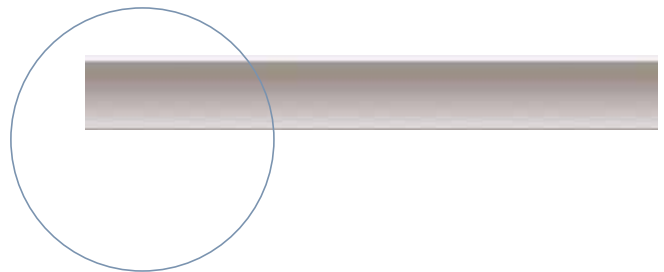
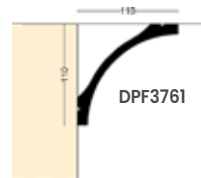

Boiserie

- DPF3862 * cm 95x160 telaio pretagliato / *pre-cut frame*
- DPF3953 ** cm 75x140 telaio assemblato / *assembled frame*
- DPF3863 * cm 95x80 telaio pretagliato / *pre-cut frame*
- DPF3954 ** cm 75x60 telaio assemblato / *assembled frame*
- DPF3864 * cm 110x160 telaio pretagliato / *pre-cut frame*
- DPF3955 ** cm 90x140 telaio assemblato / *assembled frame*
- DPF3865 * cm 110x80 telaio pretagliato / *pre-cut frame*
- DPF3956 ** cm 90x60 telaio assemblato / *assembled frame*

SCHEMA DI MONTAGGIO / ASSEMBLY SCHEME

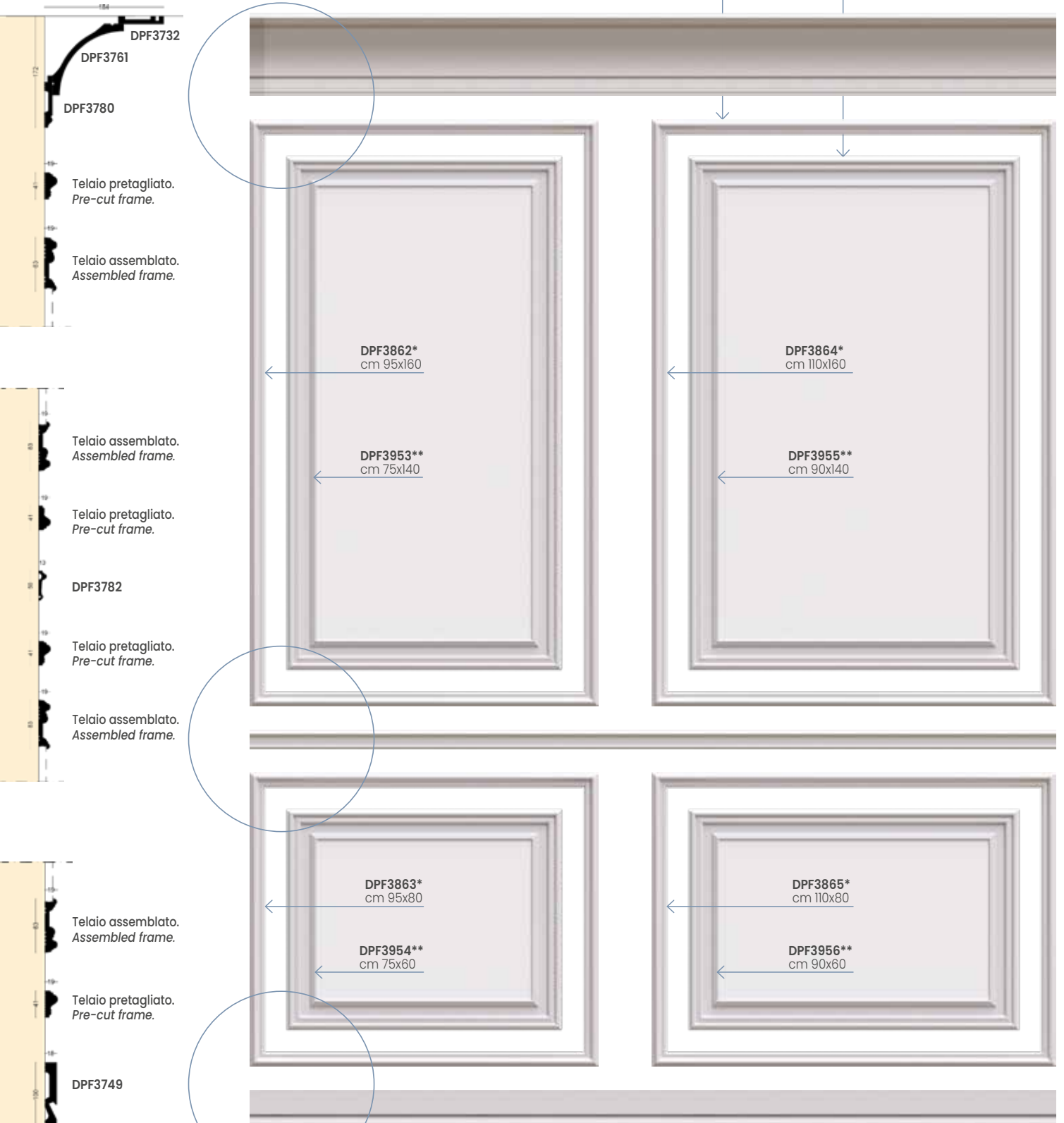



01 DPF3749 Battiscopa LED / LED Skirting boards - Pag. 96

02 DPF3865* Telaio pretagliato / Pre-cut frame - Pag. 60

03 DPF3956** Telaio assemblato / Assembled frame - Pag. 60

04 DPF3782 Marcapiano / Skirting boards - Pag. 35

05 DPF3864* Telaio pretagliato / Pre-cut frame - Pag. 60

06 DPF3955** Telaio assemblato / Assembled frame - Pag. 60

07 DPF3780 Sguscio composto / Composed coving element - Pag. 103 - 92

08 DPF3761 Sguscio composto / Composed coving element - Pag. 90 - 92

09 DPF3732 Sguscio composto / Composed coving element - Pag. 34 - 92

10 DPF3939** Telaio assemblato / Assembled frame - Pag. 76



Collanti dedicati. Per quantità vedi listino.
Dedicated glues. For quantity see price list.
COL3589-COL3590
COL3591 (sigillante / sealant)

Vedi pagine
collanti
See gluing pages
176 - 177



FACILE INSTALLAZIONE
EASY INSTALLATION



VERNICIABILE
PAINTABLE



IMPERMEABILE
WATERPROOF

Dare forma alle idee per il vivere contemporaneo.



teykos

Shaping ideas for contemporary living.



Boiserie



01 DPF3766 Battiscopa / Skirting boards - Pag. 99

02 DPF3925 Rosetta / Rosette - Pag. 65

03 DPF3819 Centina / Curve - Pag. 65

04 DPF3818 Cornice Boiserie / Boiserie Frame - Pag. 75

05 DPF3734 Marcapiano / Skirting boards - Pag. 34

06 DPF3813 Sguscio / Coving element - Pag. 91

07 DPF3776 Cornice soffitto / Ceiling frame - Pag. 75

 Collanti dedicati. Per quantità vedi listino.
Dedicated glues. For quantity see price list.
COL3589-COL3590
COL3591 (sigillante / sealant)

Vedi pagine
collanti
See gluing pages
176 - 177



FACILE INSTALLAZIONE
EASY INSTALLATION



VERNICIABILE
PAINTABLE



IMPERMEABILE
WATERPROOF



DPF3819



DPF 3818



DPF3926
Ø 6,5 cm



DPF3925
Ø 6 cm



DPF3813



DPF3776



DPF3734

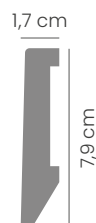

DPF3766

RESINA / RESIN



Coordinati
cornici Boiserie.
Coordinated
Boiserie frames.

Boiserie

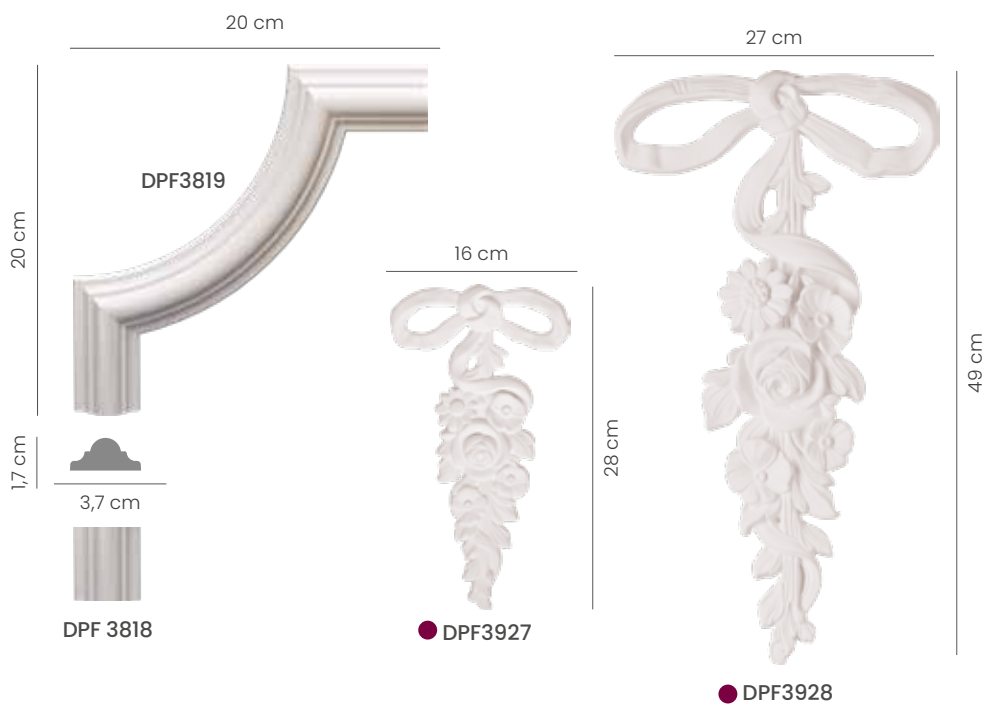

RESINA / RESIN



Coordinati
cornici LED.
Coordinated
LED frames.



01 DPF3747 Battiscopa / Skirting boards - Pag. 100

02 DPF3818 Cornice boiserie / Boiserie Frame - Pag. 75

03 DPF3819 Centina / Curve - Pag. 65

04 DPF3745 Marcapiano / Skirting boards - Pag. 35

05 DPF3927 Decoro / Decor - Pag. 66

06 DPF3759 Cornice LED / LED frame - Pag. 86

07 DPF3785 Sguscio / Coving element - Pag. 91

08 DPF3776 Cornice soffitto / Ceiling frame - Pag. 75

 Collanti dedicati. Per quantità vedi listino.
Dedicated glues. For quantity see price list.
COL3589-COL3590
COL3591 (sigillante / sealant)

Vedi pagine
collanti
See gluing pages
176 - 177



FACILE INSTALLAZIONE
EASY INSTALLATION



VERNICIABILE
PAINTABLE



IMPERMEABILE
WATERPROOF





Boiserie



01 DPF3804 Coprimarmo rivestito / Covered marble cover - Pag. 109

02 DPF3926 Rosetta / Rosette - Pag. 71

03 DPF3820 Centina / Curve - Pag. 71

04 DPF3746 Cornice / Frame - Pag. 75

05 DPF3810 Paraspigolo rivestito / Covered corner protection - Pag. 111

06 DPF3787 Sguscio / Coving element - Pag. 90

 Collanti dedicati. Per quantità vedi listino.
Dedicated glues. For quantity see price list.
COL3589-COL3590
COL3591 (sigillante / sealant)

Vedi pagine
collanti
See gluing pages
176 - 177



FACILE INSTALLAZIONE
EASY INSTALLATION



VERNICIABILE
PAINTABLE



IMPERMEABILE
WATERPROOF



RIVESTITO
COVERED

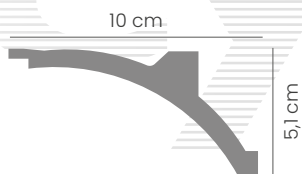

DPF3787

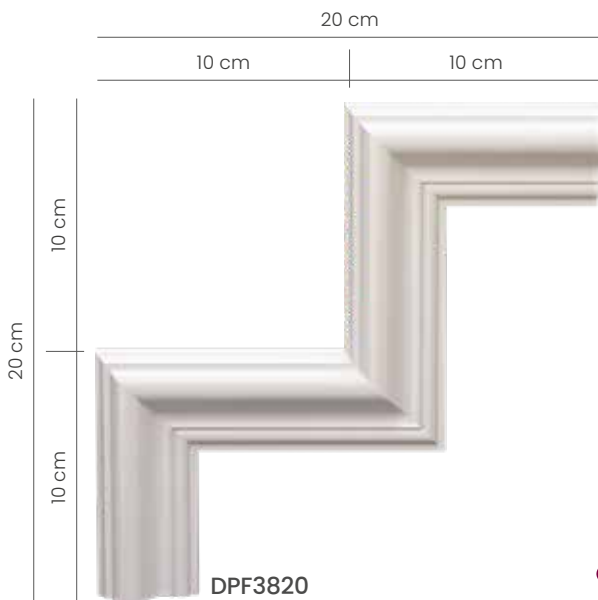

DPF3820



DPF3746



DPF3926
Ø 6,5 cm



DPF3925
Ø 6 cm

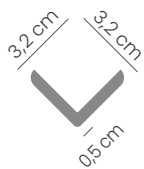

DPF3810
Rivestito rovere
Oak coated

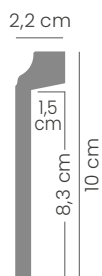

DPF3804
Rivestito rovere
Oak coated

RESINA / RESIN



Coordinati
coprimarmo e paraspigoli.
Coordinated
marble cover and covered
edge protectors.

Boiserie

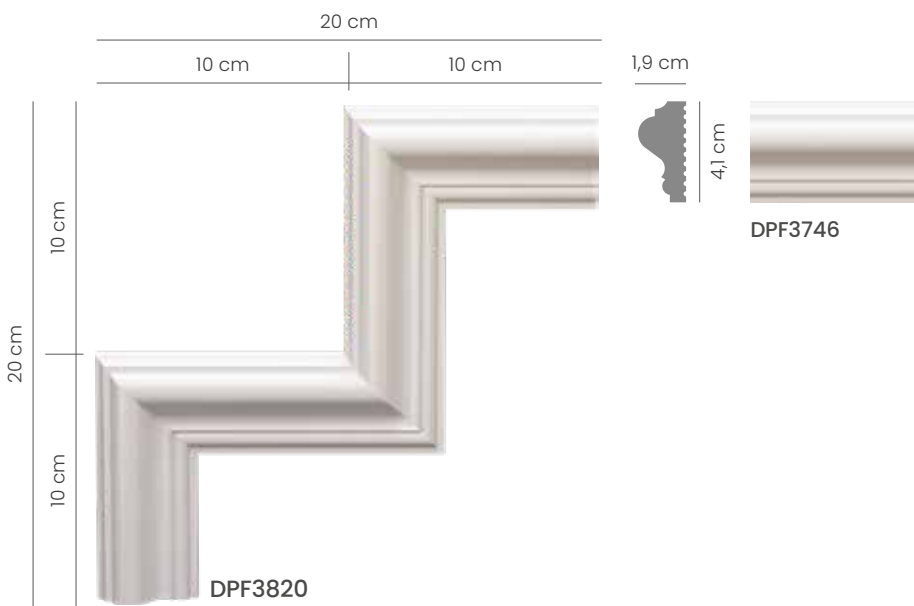

Coordinati
Battiscopa rivestiti.
Coordinated
covered skirting board.





01 DPF3798 Battiscopa rivestito / Covered skirting boards - Pag. 105

02 DPF3746 Cornice Boiserie / Boiserie Frame - Pag. 75

03 DPF3820 Centina / Curve - Pag. 72

04 DPF3736 Cornice / Frame - Pag. 74

05 DPF3813 Sguscio / Coving element - Pag. 91

 Collanti dedicati. Per quantità vedi listino.
Dedicated glues. For quantity see price list.
COL3589 - COL3590
COL3591 (sigillante / sealant)

Vedi pagine
collanti
See gluing pages
176 - 177



FACILE INSTALLAZIONE
EASY INSTALLATION



VERNICIABILE
PAINTABLE



IMPERMEABILE
WATERPROOF



RIVESTITO
COVERED

Cornici

FRAMES



0,8 cm



1,1 cm

3,2 cm



3 cm



10 cm

2,7 cm



1,4 cm

1,9 cm



0,7 cm



2,6 cm



 Collanti dedicati. Per quantità vedi listino.
Dedicated glues. For quantity see price list.
COL3589-COL3590
COL3591 (sigillante / sealant)

Vedi pagine collanti
See gluing pages
176 - 177



FACILE INSTALLAZIONE
EASY INSTALLATION



VERNICIABILE
PAINTABLE



IMPERMEABILE
WATERPROOF

teykos



Cassettonato

COFFERING ELEMENTS

DPF3941** cm 120X60 telaio assemblato / *assembled frame*

DPF3940** cm 60X60 telaio assemblato / *assembled frame*

DPF3939** cm 50X50 telaio assemblato / *assembled frame*

DPF3938** cm 40X40 telaio assemblato / *assembled frame*

TELAIO ASSEMBLATO CON
ASSEMBLED FRAME WITH
DPF3757

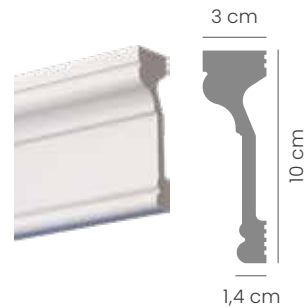

DPF3941**
cm 120 x 60



DPF3940**
cm 60 x 60



DPF3939**
cm 50 x 50



DPF3938**
cm 40 x 40



DPF3929
Ø cm 17



 Collanti dedicati. Per quantità vedi listino.
Dedicated glues. For quantity see price list.
COL3589-COL3590
COL3591 (sigillante / *sealant*)

Vedi pagine
collanti
See gluing pages
176 - 177



FACILE INSTALLAZIONE
EASY INSTALLATION



VERNICIABILE
PAINABLE



IMPERMEABILE
WATERPROOF

 **RESINA / RESIN**



Lesene, liste da porta e finestre

PILASTERS, DOOR FRAMES AND WINDOWS

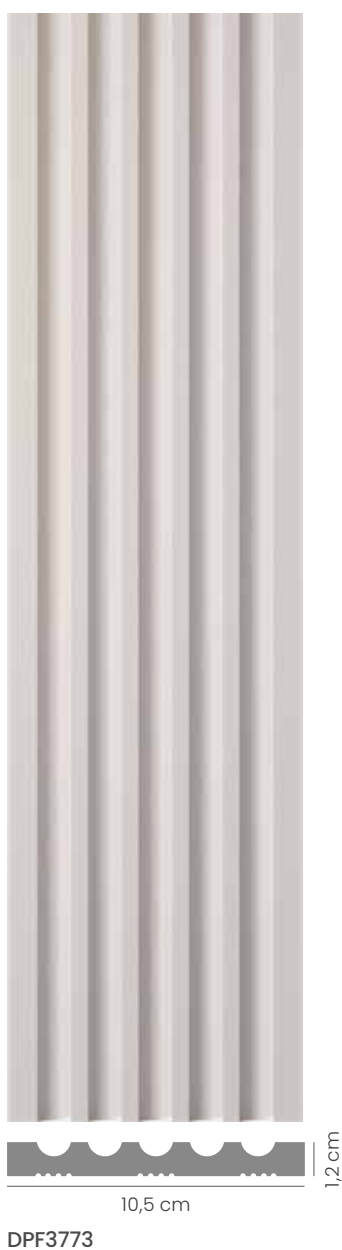
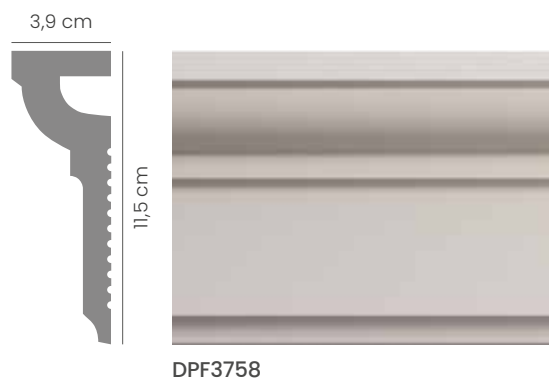

 Collanti dedicati. Per quantità vedi listino.
Dedicated glues. For quantity see price list.
COL3589-COL3590
COL3591 (sigillante / sealant)

Vedi pagine collanti
See gluing pages
176 - 177



FACILE INSTALLAZIONE
EASY INSTALLATION



VERNICIABILE
PAINTABLE



IMPERMEABILE
WATERPROOF





Lesene, liste da porta e finestre



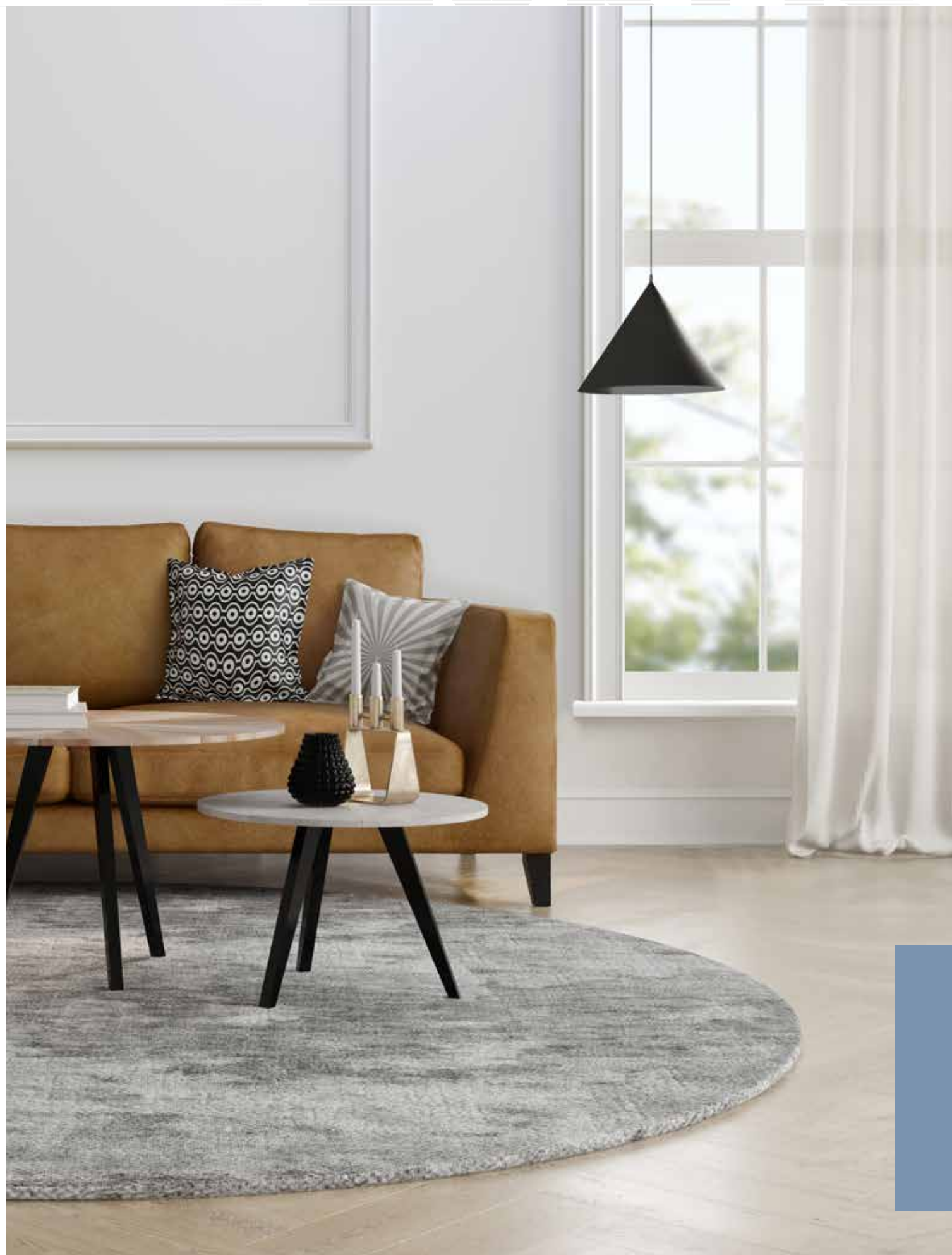

Lesene, liste da porta e finestre

PILASTERS, DOOR FRAMES AND WINDOWS

● DPF3934

DPF3823



● DPF3935

DPF3788



● DPF3933

● DPF3930

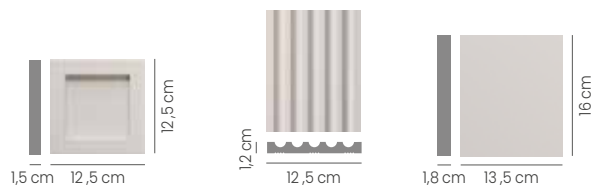
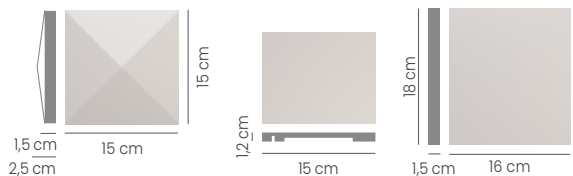

● DPF3934

DPF3823

● DPF3933

● DPF3935

DPF3788

● DPF 3930

teykos

● DPF3936

DPF3773

● DPF3937

DPF3744

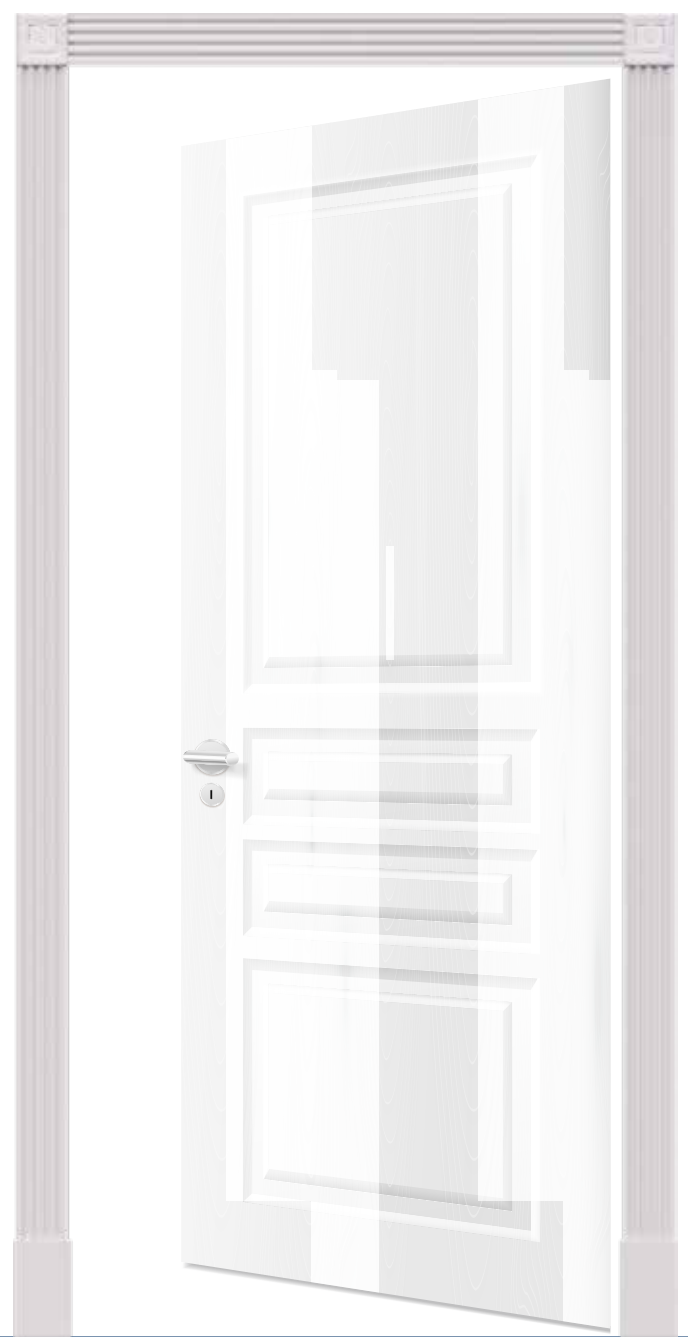

● DPF3931

● DPF3932

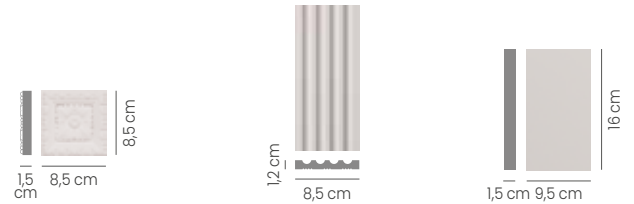
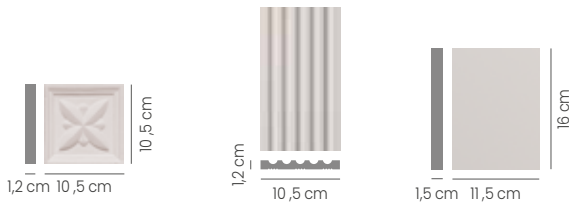

● DPF3936

DPF3773

● DPF3931

● DPF3937

DPF3744

● DPF3932

 Collanti dedicati. Per quantità vedi listino.
Dedicated glues. For quantity see price list.
COL3589-COL3590
COL3591 (sigillante / sealant)

Vedi pagine collanti
See gluing pages
176 - 177



FACILE INSTALLAZIONE
EASY INSTALLATION



VERNICIABILE
PAINTABLE



IMPERMEABILE
WATERPROOF

● RESINA / RESIN

Lesene, liste da porta e finestre

PILASTERS, DOOR FRAMES AND WINDOWS



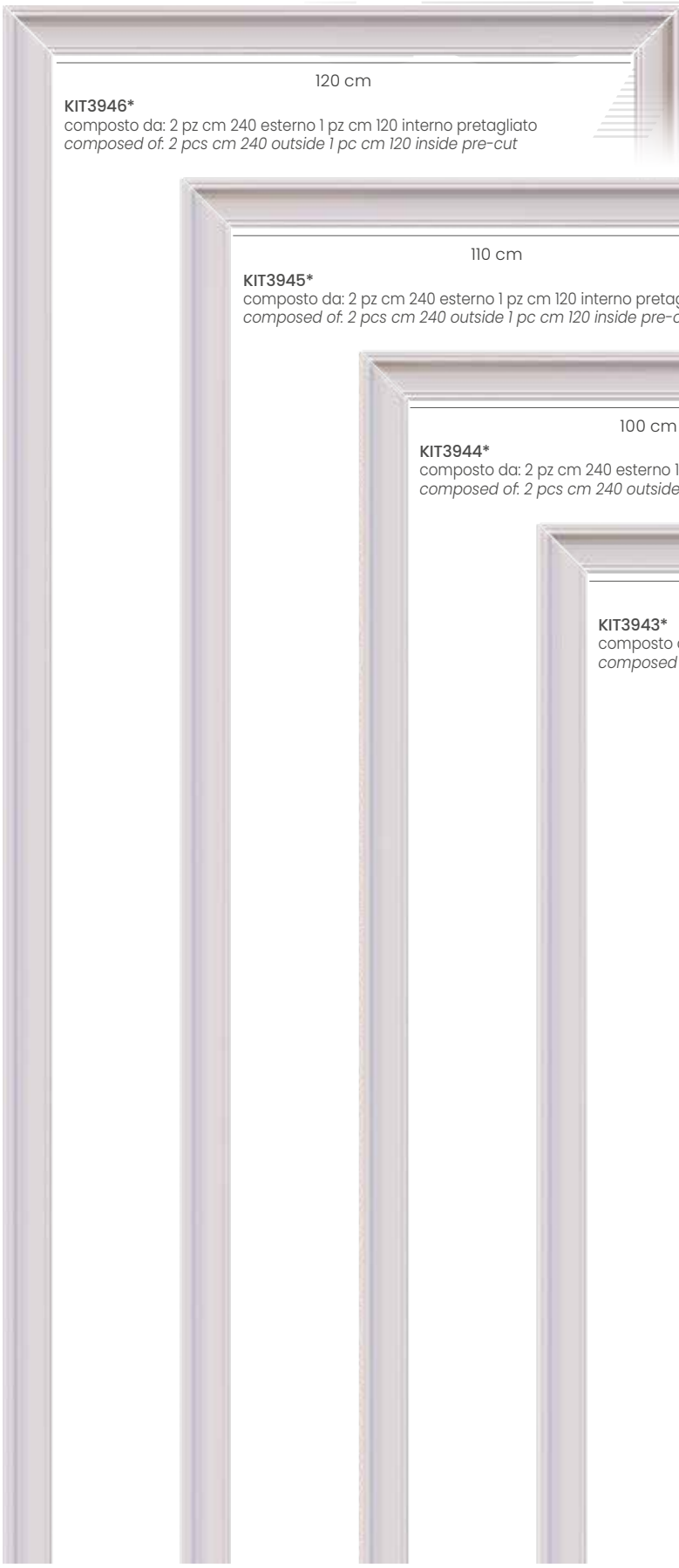

120 cm

KIT3946*
 composto da: 2 pz cm 240 esterno 1 pz cm 120 interno pretagliato
 composed of: 2 pcs cm 240 outside 1 pc cm 120 inside pre-cut



110 cm

KIT3945*
 composto da: 2 pz cm 240 esterno 1 pz cm 120 interno pretagliato
 composed of: 2 pcs cm 240 outside 1 pc cm 120 inside pre-cut

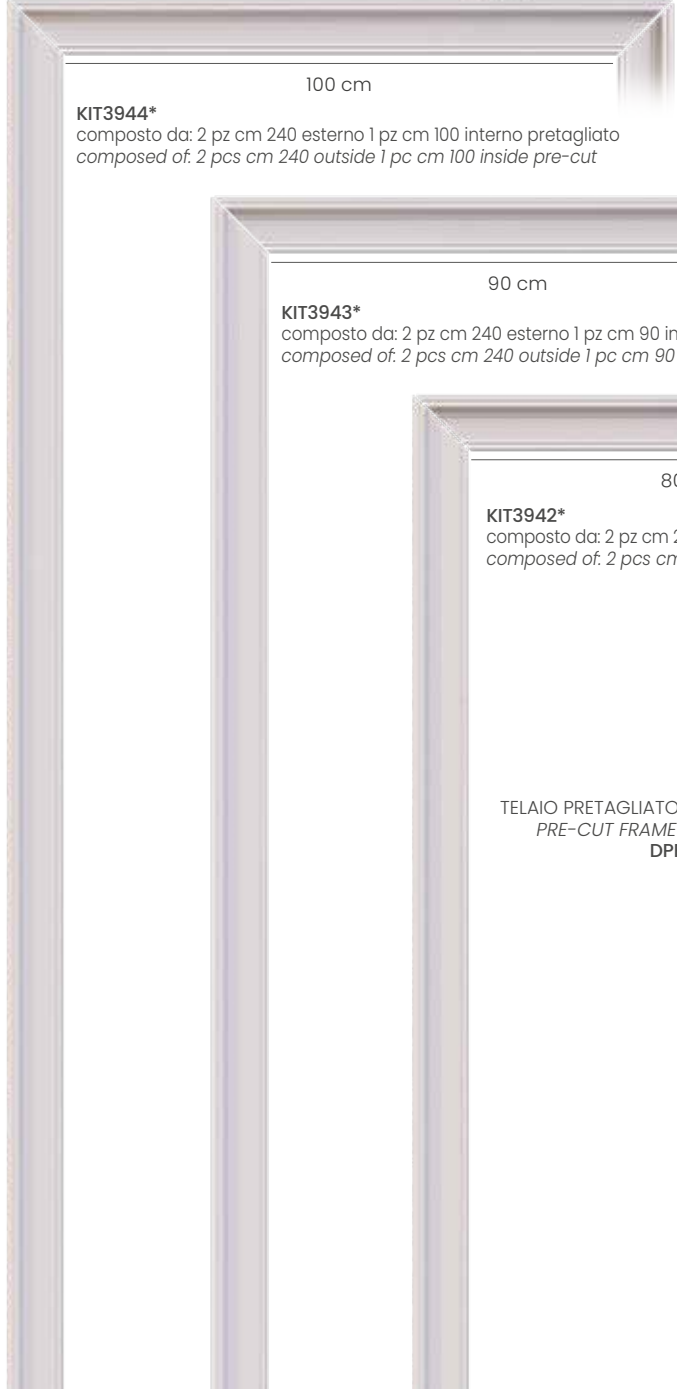

100 cm

KIT3944*
 composto da: 2 pz cm 240 esterno 1 pz cm 100 interno pretagliato
 composed of: 2 pcs cm 240 outside 1 pc cm 100 inside pre-cut



90 cm

KIT3943*
 composto da: 2 pz cm 240 esterno 1 pz cm 90 interno pretagliato
 composed of: 2 pcs cm 240 outside 1 pc cm 90 inside pre-cut



80 cm

KIT3942*
 composto da: 2 pz cm 240 esterno 1 pz cm 80 interno pretagliato
 composed of: 2 pcs cm 240 outside 1 pc cm 80 inside pre-cut

TELAIO PRETAGLIATO CON
 PRE-CUT FRAME WITH
 DPF3757



 Collanti dedicati. Per quantità vedi listino.
 Dedicated glues. For quantity see price list.
COL3589-COL3590
COL3591 (sigillante / sealant)

Vedi pagine
 collanti
 See gluing pages
 176 - 177



FACILE INSTALLAZIONE
 EASY INSTALLATION



VERNICIABILE
 PAINTABLE



IMPERMEABILE
 WATERPROOF

Cornici LED

LED FRAMES

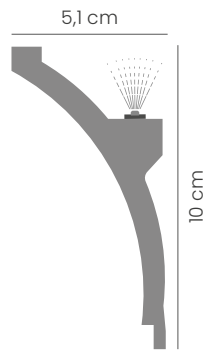

DPF3787

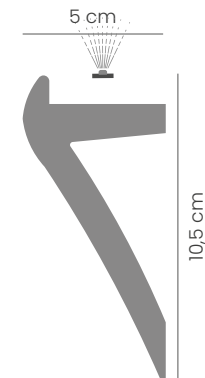

DPF3924

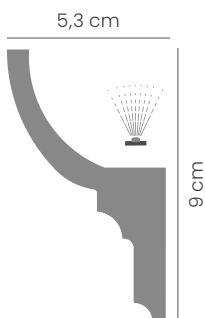
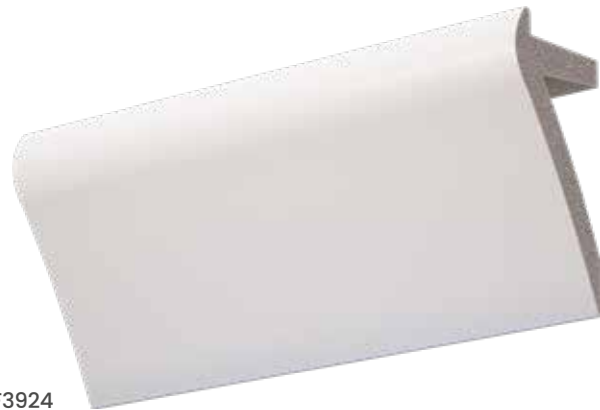

DPF3759

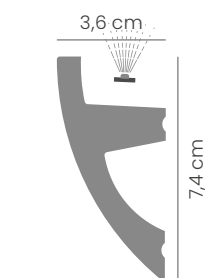

DPF3760

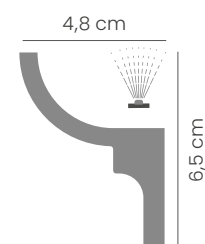

DPF3740





 Collanti dedicati. Per quantità vedi listino.
Dedicated glues. For quantity see price list.
COL3589-COL3590
COL3591 (sigillante / sealant)

Vedi pagine
collanti
See gluing pages
176 - 177



FACILE INSTALLAZIONE
EASY INSTALLATION



VERNICIABILE
PAINTABLE



IMPERMEABILE
WATERPROOF

Cornici LED

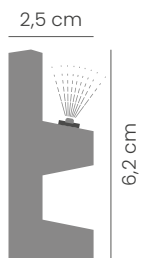

DPF3737

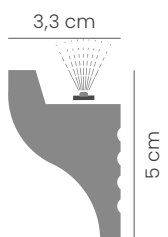
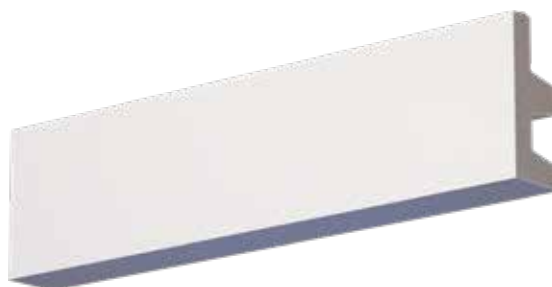

DPF3738

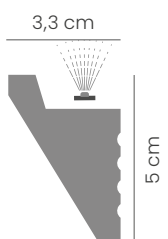

DPF3739

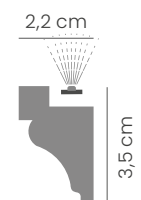

DPF3756

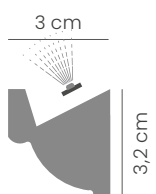

DPF3742



DPF3741



 Collanti dedicati. Per quantità vedi listino.
Dedicated glues. For quantity see price list.
COL3589-COL3590
COL3591 (sigillante / sealant)

Vedi pagine collanti
See gluing pages
176 - 177



FACILE INSTALLAZIONE
EASY INSTALLATION



VERNICIABILE
PAINTABLE





IMPERMEABILE
WATERPROOF

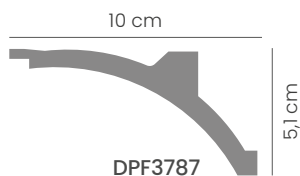
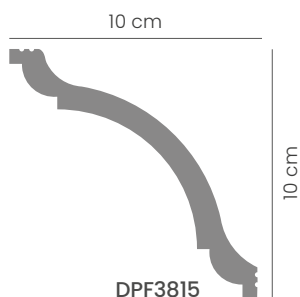
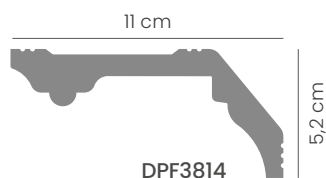
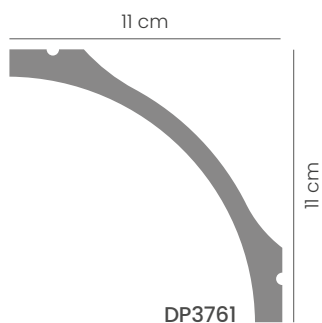

Sgusci

COVING ELEMENTS



 Collanti dedicati. Per quantità vedi listino.
Dedicated glues. For quantity see price list.
COL3589-COL3590
COL3591 (sigillante / sealant)

Vedi pagine
collanti
See gluing pages
176 - 177



FACILE INSTALLAZIONE
EASY INSTALLATION



VERNICIABILE
PAINTABLE



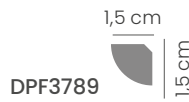
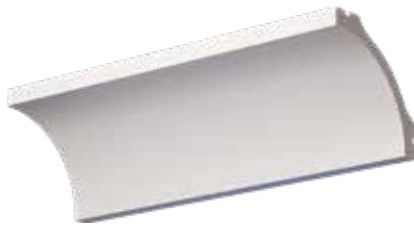
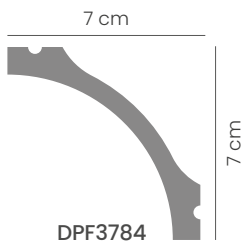
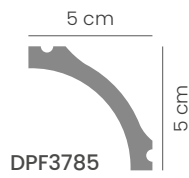
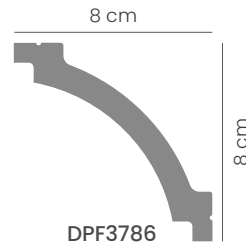
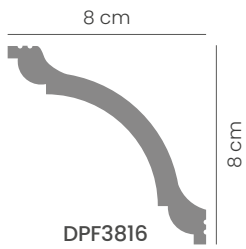
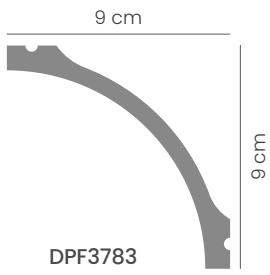

IMPERMEABILE
WATERPROOF

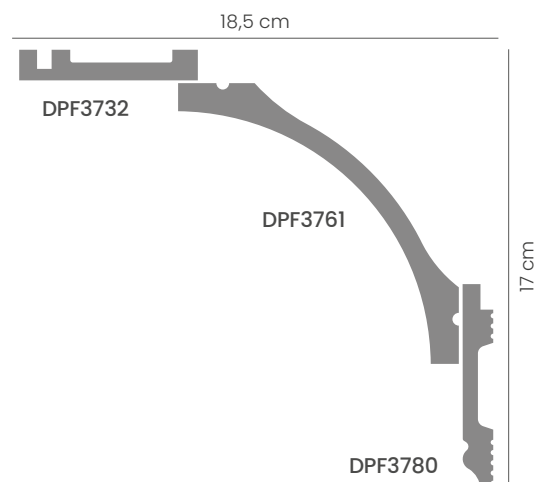
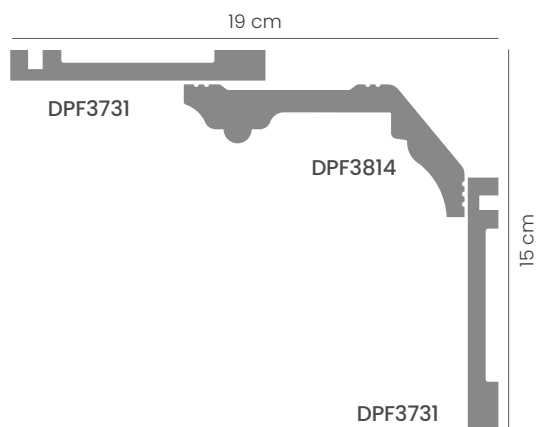
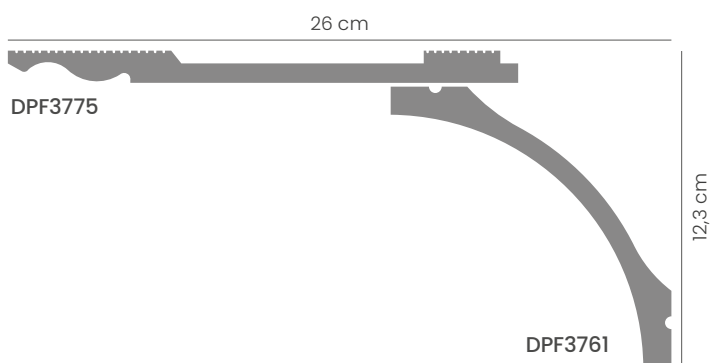

Sgusci composti

COMPOSED COVING ELEMENTS



 Collanti dedicati. Per quantità vedi listino.
Dedicated glues. For quantity see price list.
COL3589-COL3590
COL3591 (sigillante / sealant)

Vedi pagine
collanti
See gluing pages
176 - 177



FACILE INSTALLAZIONE
EASY INSTALLATION



VERNICIABILE
PAINTABLE



IMPERMEABILE
WATERPROOF

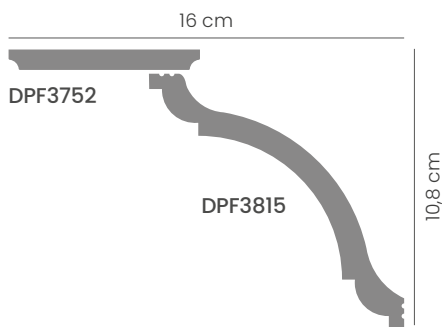
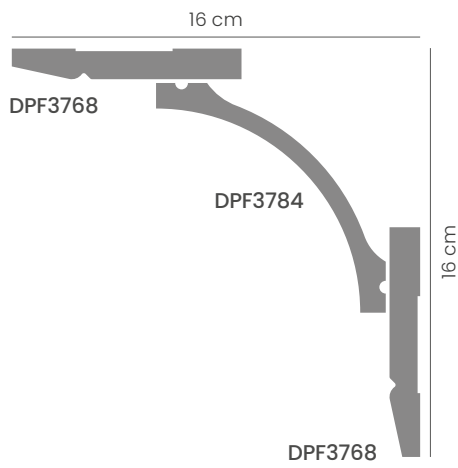
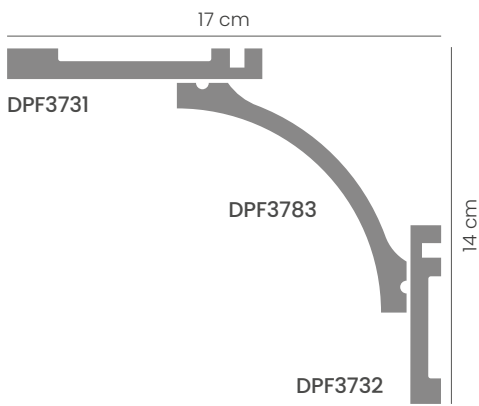
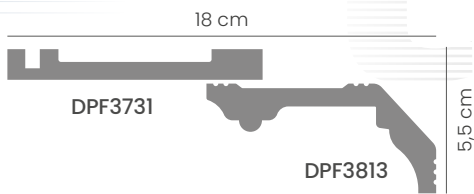

Sgusci composti LED

LED COMPOSED
COVING ELEMENTS

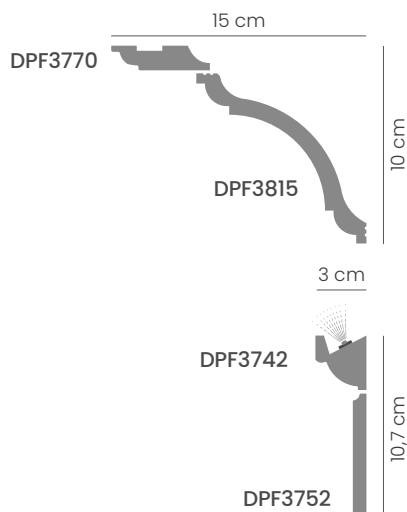
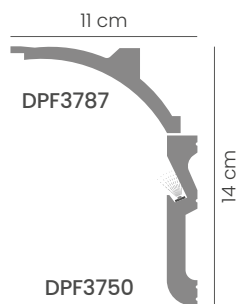
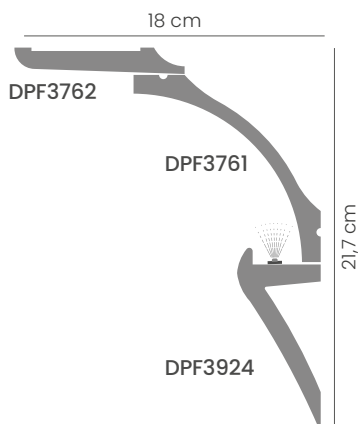
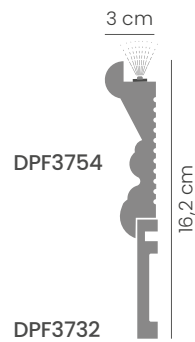
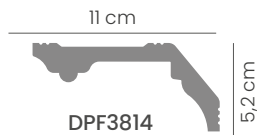



Battiscopa LED

LED SKIRTING BOARDS

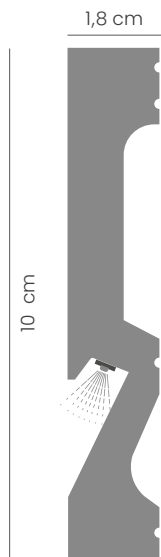

DPF3749

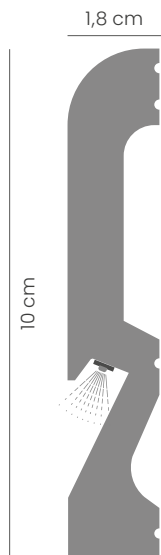

DPF3750

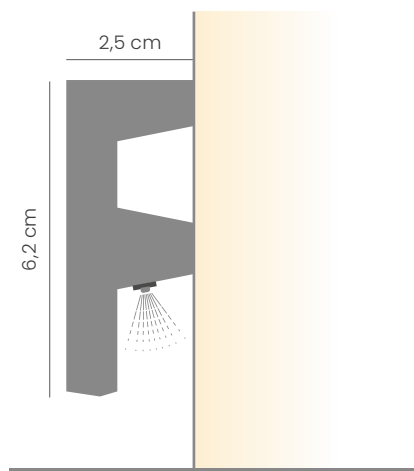

DPF3737

 Collanti dedicati. Per quantità vedi listino.
Dedicated glues. For quantity see price list.
COL3589-COL3590
COL3591 (sigillante / sealant)

Vedi pagine collanti
See gluing pages
176 - 177



FACILE INSTALLAZIONE
EASY INSTALLATION



VERNICIABILE
PAINTABLE



IMPERMEABILE
WATERPROOF



Scheda tecnica Art. DPF3737.
Data sheet Art. DPF3737.



Battiscopa moderni

MODERN SKIRTING BOARDS

1,5 cm



15 cm



DPF3765

1,2 cm



15 cm

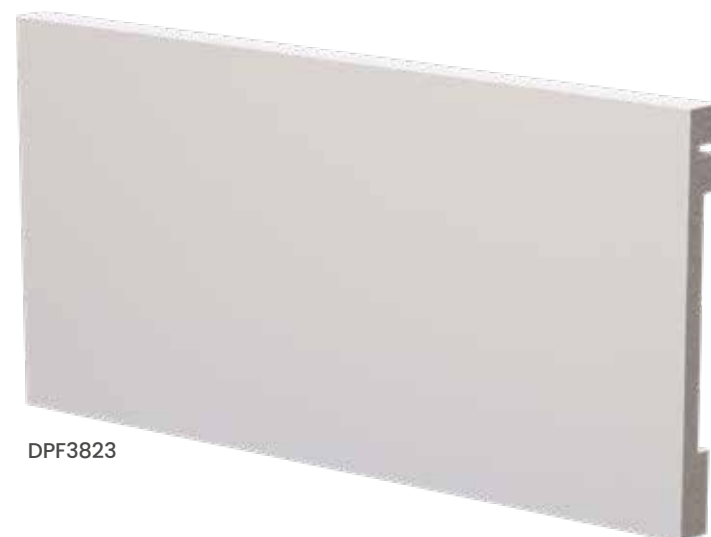

DPF3823

1,5 cm



10 cm



DPF3762

 Collanti dedicati. Per quantità vedi listino.
Dedicated glues. For quantity see price list.
COL3589-COL3590
COL3591 (sigillante / sealant)

Vedi pagine
collanti
See gluing pages
176 - 177



FACILE INSTALLAZIONE
EASY INSTALLATION



VERNICIABILE
PAINTABLE



IMPERMEABILE
WATERPROOF

1,2 cm



10 cm



DPF3731

1,2 cm



9 cm



DPF3768

1,7 cm



7,9 cm

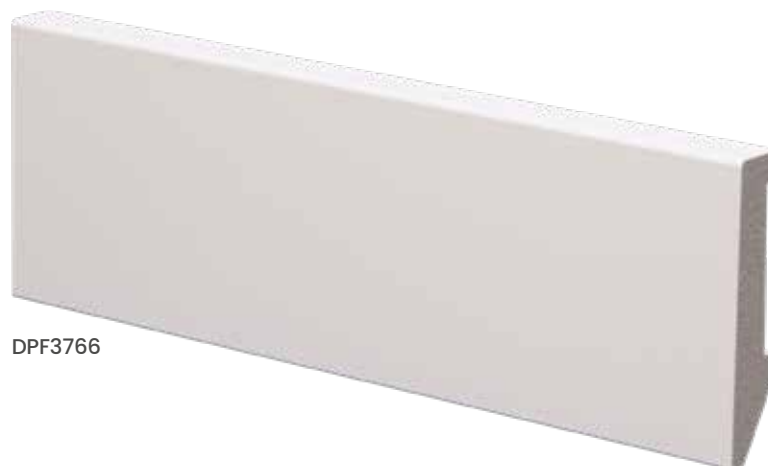

DPF3766

Battiscopa moderni

MODERN SKIRTING BOARDS

1,2 cm



7 cm



DPF3732

1,2 cm



7 cm



DPF3763

1,5 cm



5,8 cm

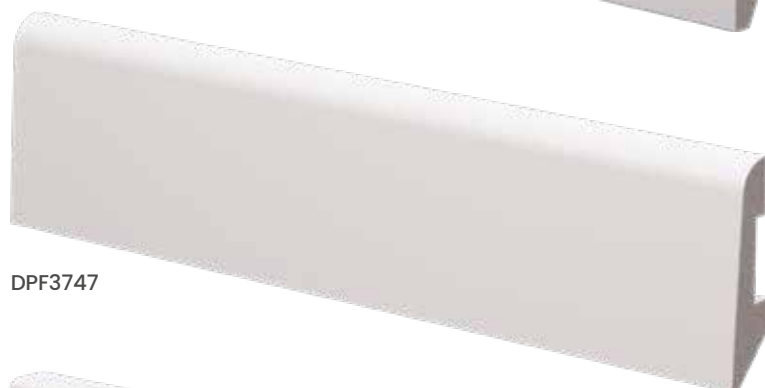

DPF3747

1,7 cm



4 cm



DPF3748

1,5 cm



4 cm

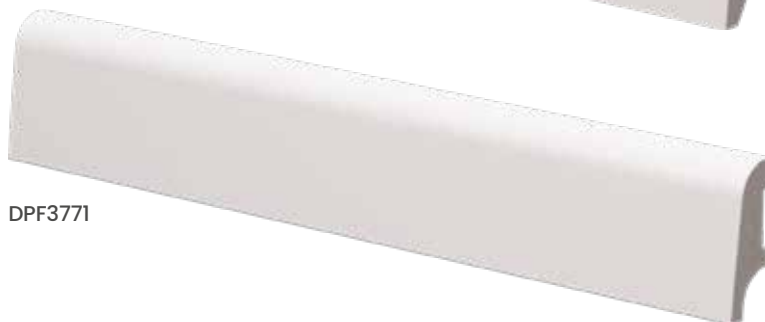

DPF3771

 Collanti dedicati. Per quantità vedi listino.
Dedicated glues. For quantity see price list.
COL3589-COL3590
COL3591 (sigillante / sealant)

Vedi pagine
collanti
See gluing pages
176 - 177



FACILE INSTALLAZIONE
EASY INSTALLATION



VERNICIABILE
PAINTABLE



IMPERMEABILE
WATERPROOF





Battiscopa classici

CLASSIC SKIRTING BOARDS



 Collanti dedicati. Per quantità vedi listino.
Dedicated glues. For quantity see price list.
COL3589-COL3590
COL3591 (sigillante / sealant)

Vedi pagine
collanti
See gluing pages
176 - 177



FACILE INSTALLAZIONE
EASY INSTALLATION



VERNICIABILE
PAINTABLE



IMPERMEABILE
WATERPROOF

1,4 cm



DPF3769



1,2 cm



DPF3780



1,3 cm

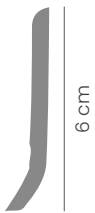

DPF3767

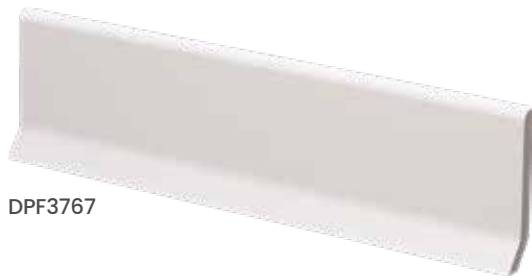

1,5 cm



DPF3770



Battiscopa rivestiti

COVERED SKIRTING BOARDS

1,5 cm



8 cm



DPF3791
Bianco / White



DPF3792
Noce chiaro / Light walnut



DPF3793
Noce scuro / Dark walnut



DPF3794
Rovere / Oak



DPF3795
Mogano / Mahogany

 Collanti dedicati. Per quantità vedi listino.
Dedicated glues. For quantity see price list.
COL3589-COL3590
COL3591 (sigillante / sealant)

Vedi pagine
collanti
See gluing pages
176 - 177



FACILE INSTALLAZIONE
EASY INSTALLATION



VERNICIABILE
PAINTABLE



IMPERMEABILE
WATERPROOF



RIVESTITO
COVERED



DPF3796
Rovere Groenlandia / *Groenlandia Oak*



DPF3797
Rovere sbiancato / *Bleached Oak*



DPF3798
Teak / *Teak*



DPF3799
Acero ghiaccio / *Ice malpe*



DPF3800
Alluminio / *Aluminum*



Coordinati
coprimarmo e parasigoli.
*Coordinated
marble cover and coated
edge protectors.*



Battiscopa rivestiti

COVERED SKIRTING BOARDS



DPF3909
Bianco naturale / *Natural white*

Dimensioni / *Size*: 5x1,8x200 cm
Confezioni / *Packages*: 64 ml



Profili rivestiti / *Covered profiles*



DPF3902
Rovere Praga / *Praque Oak*

Dimensioni / *Size*: 5x1,8x200 cm
Confezioni / *Packages*: 64 ml



DPF3903
Rovere Londra / *London Oak*



DPF3904
Rovere Parigi / *Paris Oak*



DPF3905
Rovere Vienna / *Vienna Oak*



DPF3906
Rovere Madrid / *Madrid Oak*



DPF3907
Bianco / *White*



DPF3908
Alluminio / *Aluminum*



FACILE INSTALLAZIONE
EASY INSTALLATION



RESISTENTE RAGGI UV
UV RESISTANT



IMPERMEABILE
WATERPROOF



RIVESTITO
COVERED

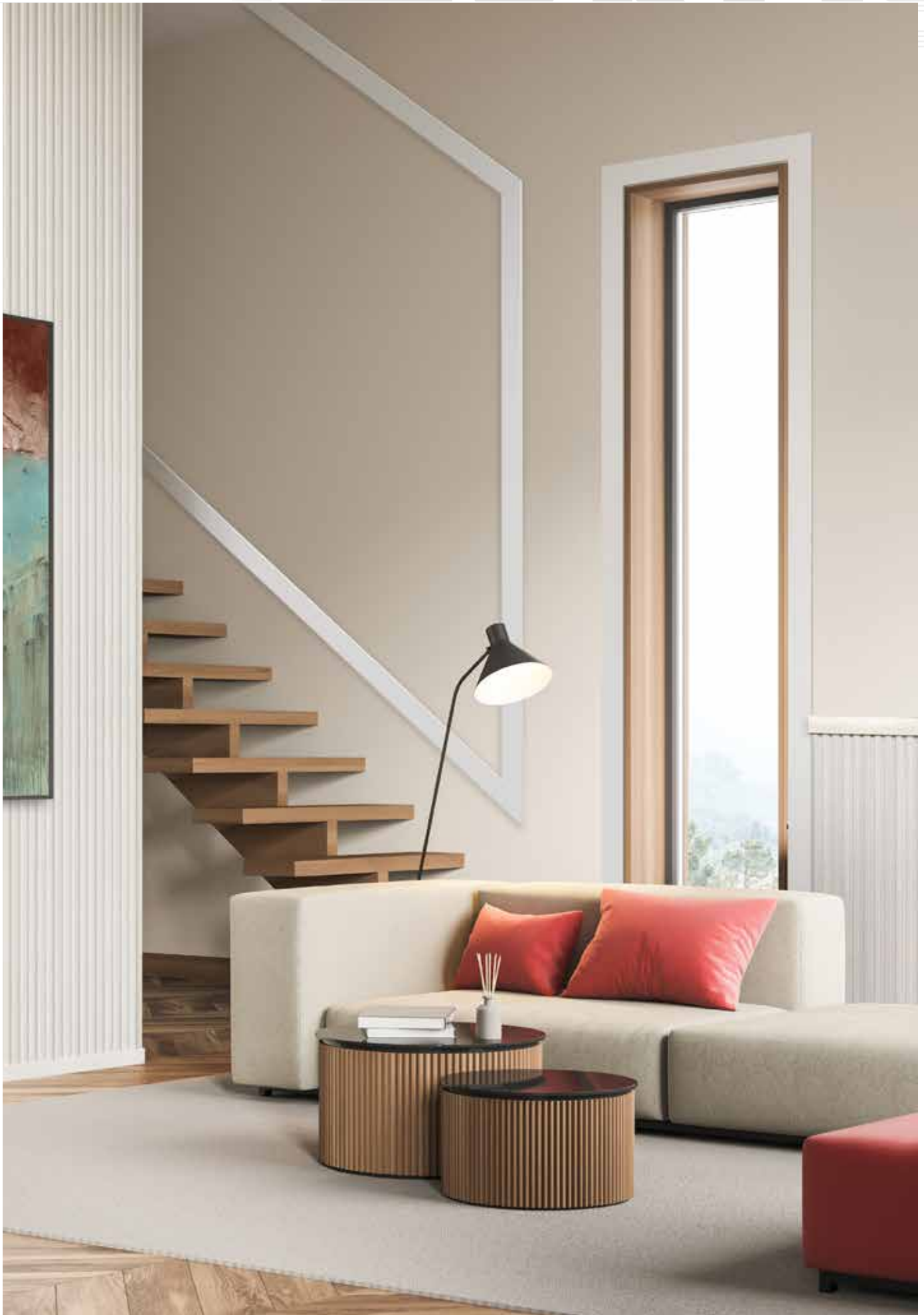

MARBLE COVER

2,2 cm

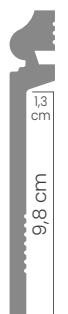

DPF3812

2,6 cm



DPF3772

2,2 cm

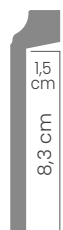

DPF3743



Coprimarmo rivestiti

COVERED MARBLE COVER

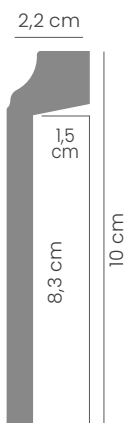

DPF3801
Rivestito bianco
White coated



DPF3802
Rivestito noce chiaro
Light walnut coated



DPF3803
Rivestito noce scuro
Dark walnut coated



DPF3804
Rivestito rovere
Oak coated



DPF3805
Rivestito mogano
Mahogany coated

 Collanti dedicati. Per quantità vedi listino.
Dedicated glues. For quantity see price list.
COL3589-COL3590
COL3591 (sigillante / sealant)

Vedi pagine
collanti
See gluing pages
176 - 177



FACILE INSTALLAZIONE
EASY INSTALLATION



VERNICIABILE
PAINTABLE



IMPERMEABILE
WATERPROOF



RIVESTITO
COVERED

Paraspigoli

EDGE PROTECTORS

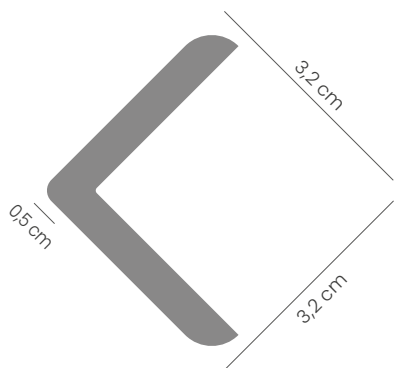

DPF3806
Bianco naturale
Natural white



 Collanti dedicati. Per quantità vedi listino.
Dedicated glues. For quantity see price list.
COL3589-COL3590
COL3591 (sigillante / sealant)

Vedi pagine
collanti
See gluing pages
176 - 177



FACILE INSTALLAZIONE
EASY INSTALLATION



VERNICIABILE
PAINTABLE



IMPERMEABILE
WATERPROOF



RIVESTITO
COVERED

Paraspigoli rivestiti

COVERED EDGE PROTECTORS

teykos

DPF3808
Noce chiaro
Light walnut



DPF3809
Noce scuro
Dark walnut



DPF3811
Mogano
Mahogany



DPF3807
Bianco
White



DPF3959
Alluminio
Aluminium



DPF3810
Rovere
Oak

Laccature RAL per profili

RAL LACQUERS FOR PROFILES



Realizziamo, su specifiche richieste da parte del cliente, laccature con vernici RAL su tutti i profili della linea Polyforte presenti in questo catalogo, ad esclusione dei rivestimenti murali.

Per ogni tipo di utilizzo, dalle boiserie montate ai singoli profili come cornici, marcapiani, battiscopa ecc; per avere qualsiasi tipo di prodotto laccato e pronto per il montaggio. Consultate il listino per verificare quantità e costo.

With specific requests from the customer we realize RAL lacquering paints on all the profiles of the Polyforte line present in this catalog, excluding the coatings murals. For every type of use, from assembled boiserie to individual profiles such as, frames, string courses, baseboards etc; to have any type of lacquered product and ready for assembly. Check the price list for quantity and costs.



Laccature profili.
Lacquering profiles.





Rivestimenti murali in Polyforte

I rivestimenti murali da interno in Polyforte, sono la risposta innovativa alla crescente domanda di soluzioni di arredo moderne, facili da installare ed originali. Sono infatti elementi di decoro utilizzabili per qualsiasi tipo di ambiente abitativo, dalla camera da letto al soggiorno, così come per la cucina o il bagno. Ideali anche per ambienti commerciali e uffici. Possono essere installati su qualsiasi tipo di superficie, sono molto resistenti, non si deformano e non si scheggiano. Hanno finiture con un effetto legno iper realistico e rappresentano uno dei principali trend dell'arredo contemporaneo.

Wall coverings in Polyforte

Interior wall coverings in Polyforte are the innovative answer to the growing demand for modern, easy to install and original furniture solutions.

They are in fact decorative elements that can be used for any type of living environment, from the bedroom to the living room, as well as for the kitchen or bathroom.

They are ideal for commercial spaces and offices.

They can be installed on any type of surface, are very durable because they do not deform and do not chip.

Finishes with a hyper realistic wood effect are available and represent one of the main trends of contemporary furniture.



INQUADRA IL QR CODE
E PERSONALIZZA I TUOI AMBIENTI.

FRAME THE QR CODE
AND CUSTOMIZE YOUR SPACES.

Rivestimenti murali

RIVESTIMENTI MURALI DA INTERNO / INDOOR WALL COVERINGS



Coordinati
rivestimenti murali.
Coordinated
wall coverings.



WP3880

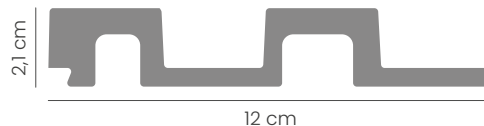

Dimensioni / Size: 12x2,1x290 cm
Confezioni / Packages: 43,5 ml



WP3881



Dimensioni / Size: 6,1x2,1x290 cm
Confezioni / Packages: 2,9 ml



WP3882

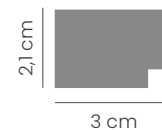

Dimensioni / Size: 3x2,1x290 cm
Confezioni / Packages: 2,9 ml

SCHEMA DI MONTAGGIO ASSEMBLY SCHEME

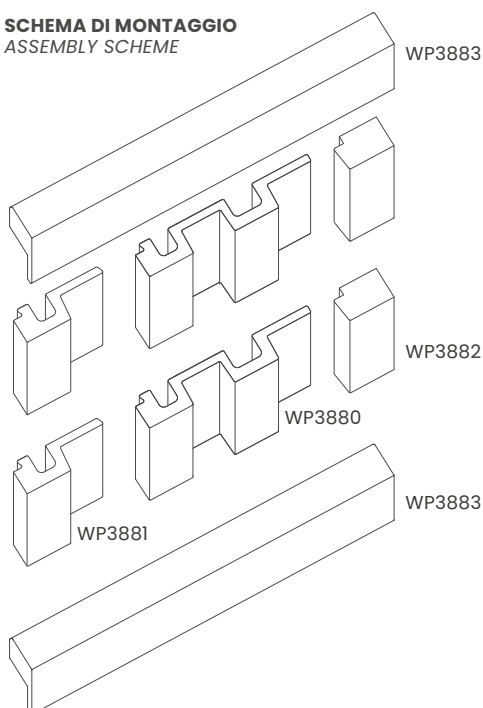

Montaggio
rivestimenti interni.
Assembly
interior coverings.



WP3883

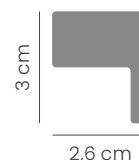

Dimensioni / Size: 3x2,6x290 cm
Confezioni / Packages: 2,9 ml

Collanti dedicati. Per quantità vedi listino.
Dedicated glues. For quantity see price list.
COL3589-COL3590
COL3591 (sigillante / sealant)

Vedi pagine collanti
See gluing pages
176 - 177



FACILE
INSTALLAZIONE
EASY
INSTALLATION



RESISTENTE RAGGI UV
UV RESISTANT



IMPERMEABILE
WATERPROOF



RIVESTITO
COVERED



ISOLANTE
INSULATING



Rivestimenti murali



WP3884

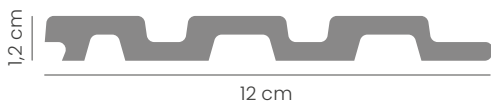

Dimensioni / Size: 12x1,2x290 cm
 Confezioni / Packages: 69,60 ml



WP3887

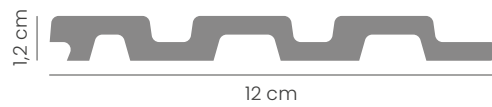

Dimensioni / Size: 12x1,2x290 cm
 Confezioni / Packages: 69,60 ml

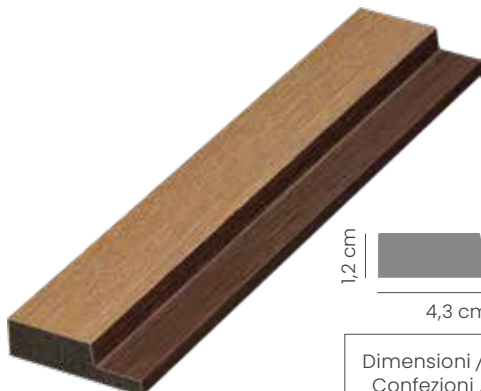

WP3885

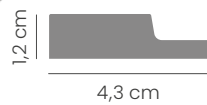

Dimensioni / Size: 4,3x1,2x290 cm
 Confezioni / Packages: 2,90 ml



WP3888

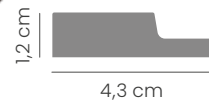

Dimensioni / Size: 4,3x1,2x290 cm
 Confezioni / Packages: 2,90 ml

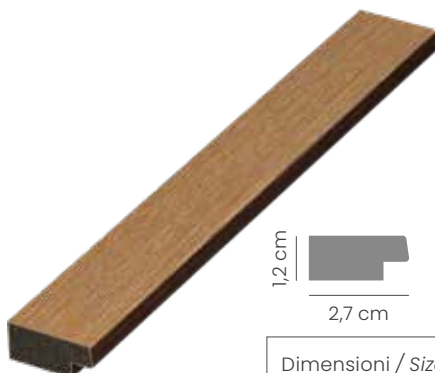

WP3886

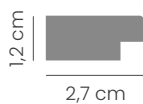

Dimensioni / Size: 2,7x1,2x290 cm
 Confezioni / Packages: 2,90 ml

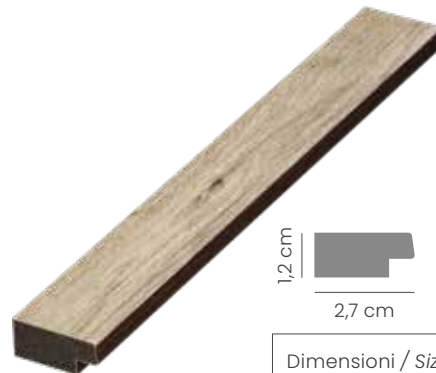

WP3889

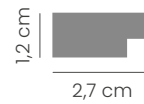

Dimensioni / Size: 2,7x1,2x290 cm
 Confezioni / Packages: 2,90 ml



DPF3902
 Rovere Praga / Prague Oak



Dimensioni / Size: 5x1,8x200 cm
 Confezioni / Packages: 2 ml



DPF3903
 Rovere Londra / London Oak



Dimensioni / Size: 5x1,8x200 cm
 Confezioni / Packages: 2 ml

Collanti dedicati. Per quantità vedi listino.
 Dedicated glues. For quantity see price list.
 COL3589-COL3590
 COL3591 (sigillante / sealant)

Vedi pagine collanti
 See gluing pages
 176 - 177



FACILE
 INSTALLAZIONE
 EASY
 INSTALLATION



RESISTENTE RAGGI UV
 UV RESISTANT



IMPERMEABILE
 WATERPROOF



RIVESTITO
 COVERED



ISOLANTE
 INSULATING

SCHEMA DI MONTAGGIO / ASSEMBLY SCHEME

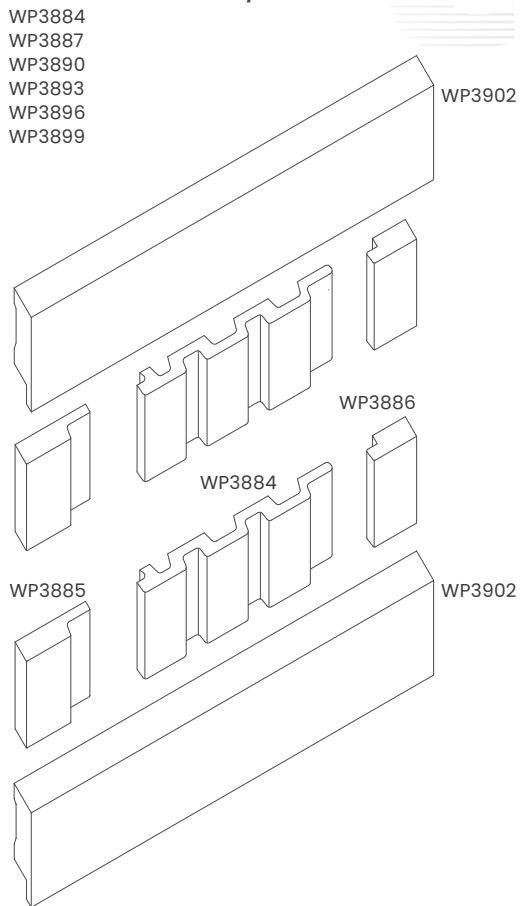



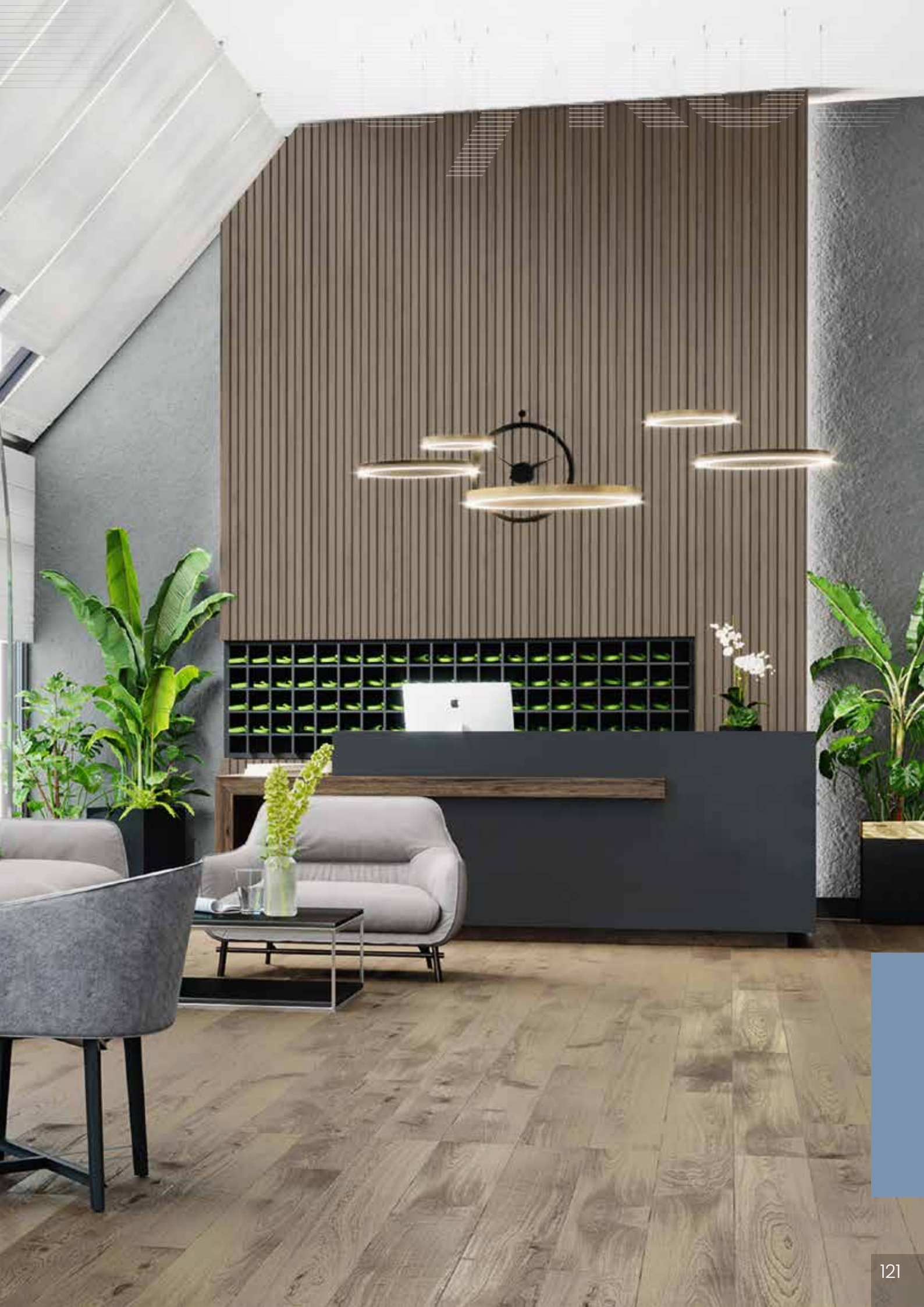

Rivestimenti murali in Polyforte



WP3890

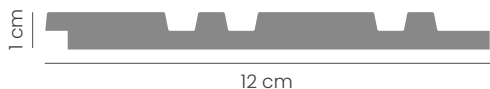

Dimensioni / Size: 12x1x290 cm
 Confezioni / Packages: 75,40 ml



WP3893

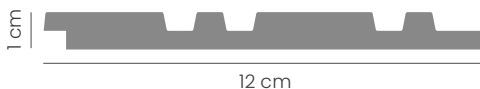

Dimensioni / Size: 12x1x290 cm
 Confezioni / Packages: 75,40 ml



WP3891

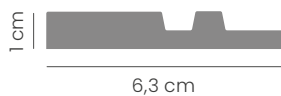

Dimensioni / Size: 6,3x1x290 cm
 Confezioni / Packages: 2,90 ml

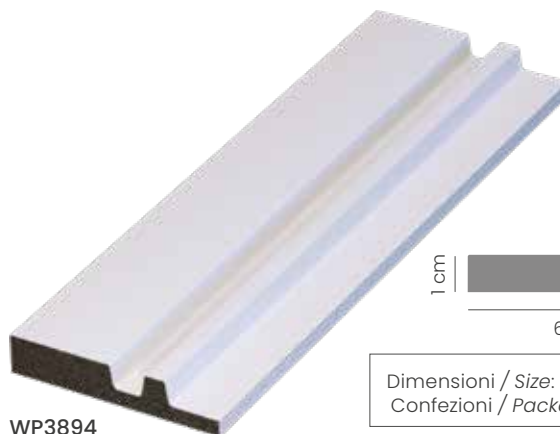

WP3894

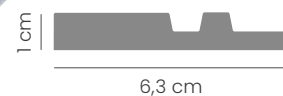

Dimensioni / Size: 6,3x1x290 cm
 Confezioni / Packages: 2,90 m

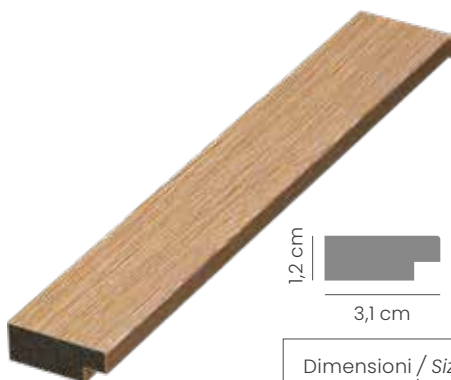

WP3892

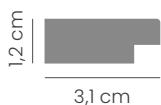

Dimensioni / Size: 3,1x1x290 cm
 Confezioni / Packages: 2,90 ml

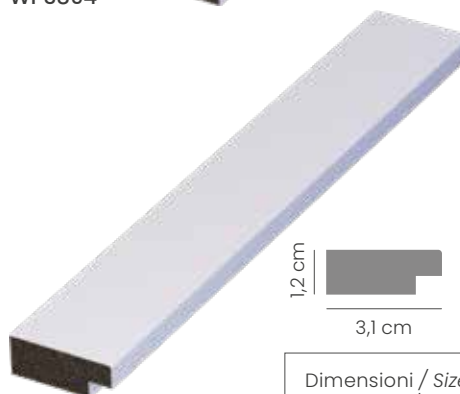

WP3895

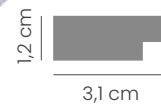

Dimensioni / Size: 3,1x1x290 cm
 Confezioni / Packages: 2,90 ml



DPF3904
 Rovere Parigi / Paris Oak



Dimensioni / Size: 5x1,8x200 cm
 Confezioni / Packages: 2 ml



DPF3907
 Bianco / White



Dimensioni / Size: 5x1,8x200 cm
 Confezioni / Packages: 2 ml

Collanti dedicati. Per quantità vedi listino.
 Dedicated glues. For quantity see price list.
 COL3589-COL3590
 COL3591 (sigillante / sealant)

Vedi pagine collanti
 See gluing pages
 176 - 177



FACILE
 INSTALLAZIONE
 EASY
 INSTALLATION



RESISTENTE RAGGI UV
 UV RESISTANT



IMPERMEABILE
 WATERPROOF



RIVESTITO
 COVERED



ISOLANTE
 INSULATING



Rivestimenti murali in Polyforte

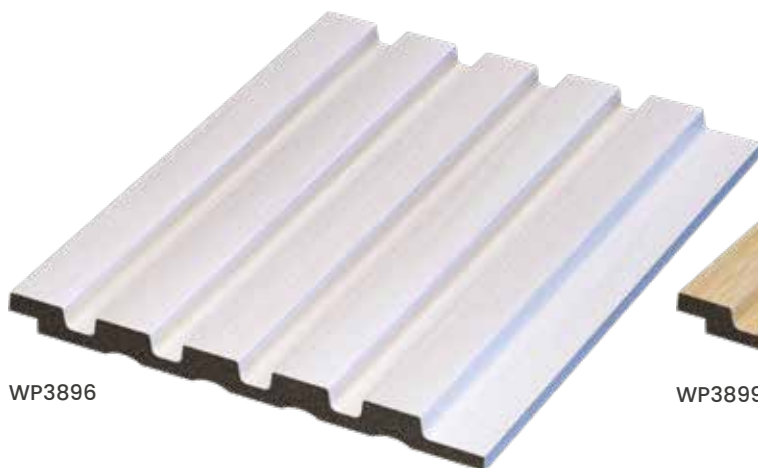

WP3896

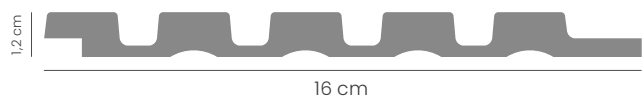

Dimensioni / Size: 16x1,2x290 cm
Confezioni / Packages: 58 ml



WP3899

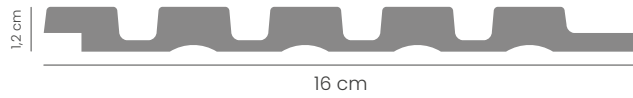

Dimensioni / Size: 16x1,2x290 cm
Confezioni / Packages: 58 ml



WP3898

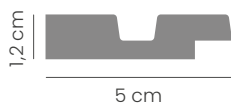

Dimensioni / Size: 5x1,2x290 cm
Confezioni / Packages: 2,90 m



WP3901

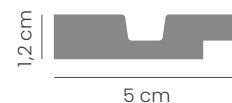

Dimensioni / Size: 5x1,2x290 cm
Confezioni / Packages: 2,90 m



WP3897

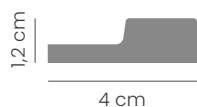

Dimensioni / Size: 4x1,2x290 cm
Confezioni / Packages: 2,90 ml



WP3900

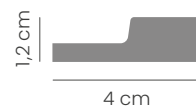

Dimensioni / Size: 4x1,2x290 cm
Confezioni / Packages: 2,90 ml



DPF3905
Rovere Vienna / Vienna Oak

Dimensioni / Size: 5x1,8x200 cm
Confezioni / Packages: 2 ml



DPF3906
Rovere Madrid / Madrid Oak

Dimensioni / Size: 5x1,8x200 cm
Confezioni / Packages: 2 ml

 Collanti dedicati. Per quantità vedi listino.
Dedicated glues. For quantity see price list.
COL3589-COL3590
COL3591 (sigillante / sealant)

Vedi pagine collanti
See gluing pages
176 - 177



FACILE
INSTALLAZIONE
EASY
INSTALLATION



RESISTENTE RAGGI UV
UV RESISTANT



IMPERMEABILE
WATERPROOF



RIVESTITO
COVERED



ISOLANTE
INSULATING





INQUADRA IL QR CODE
E PERSONALIZZA I TUOI AMBIENTI.
*FRAME THE QR CODE
AND CUSTOMIZE YOUR SPACES.*

Rivestimenti, pavimenti WPC e prato

I rivestimenti e i pavimenti per esterno, dal design contemporaneo, sono realizzati con un materiale ad alta densità composto da fibra di bamboo riciclata, polietilene e resine di coesione. Racchiudono la bellezza e la resistenza del legno, la facilità di manutenzione e la protezione del polietilene. Non si scheggiano, non si fessurano, resistono alle rotture e alle deformazioni. Sono resistenti in modo naturale a parassiti, funghi e batteri.

La collezione dei prati sintetici offre una gamma completa di spessori, densità, tonalità e sfumature che permette di scegliere la soluzione più idonea.

Dal classico 7 mm monocolori ai 20 e 30 mm con filato 4 colori fino al 40 mm con filato 4 colori e soft touch.

Tutti altamente drenanti e duraturi nel tempo.

Coatings, Wpc floors and lawn

The outdoor coverings and floors, with a contemporary design, are made of a high density material composed of recycled bamboo fiber, polyethylene and coexistence resins. They enclose the beauty and strength of wood, ease of maintenance and protection of polyethylene.

They do not splinter, do not crack, resist breakage and deformation. They are naturally resistant to parasites, fungi and bacteria.

The collection of synthetic lawns offers a complete range of thicknesses, densities, and shades that allows you to choose the most suitable solution.

From classic 7 mm monochrome to 20 and 30 mm with yarn 4 colors up to 40 mm with yarn 4 colors and soft touch.

All highly draining and long lasting.



Rivestimenti murali WPC protect

Rivestimenti murali da esterno WPC / Outdoor wall coverings WPC



Dimensioni / Size: 21,9x2,6x300 cm
 Confezioni / Packages: 2,40 mq



EWP3675 - TEAK



Dimensioni / Size: 5,5x5,5x300 cm
 Confezioni / Packages: 1 pz

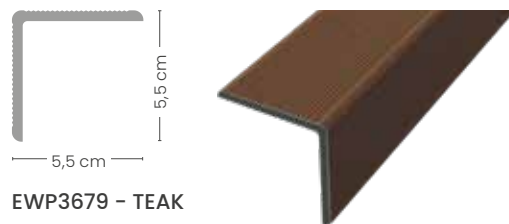

EWP3679 - TEAK



Dimensioni / Size: 21,9x2,6x300 cm
 Confezioni / Packages: 2,40 mq



EWP3674 - ANTIQUE



Dimensioni / Size: 5,5x5,5x300 cm
 Confezioni / Packages: 1 pz

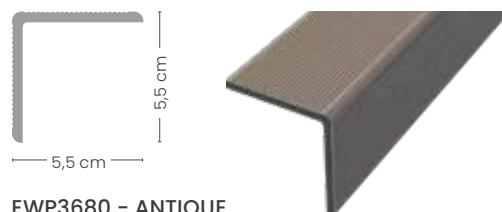

EWP3680 - ANTIQUE



Inviateci il DWG con le misure del vostro ambiente. Il nostro ufficio tecnico vi svilupperà il disegno ed il preventivo.

Send us the DWG with measurements of your space. Our technical department will develop a design and a budget for you.



Montaggio rivestimenti esterni.
 Assembly exterior coverings.



FACILE INSTALLAZIONE
 EASY INSTALLATION



RESISTENTE AGLI URTI
 IMPACT RESISTANT



RESISTENTE RAGGI UV
 UV RESISTANT



IMPERMEABILE
 WATERPROOF



Pavimentazioni da esterno WPC classic

WPC CLASSIC OUTDOOR FLOORING

Teydeck classic

La pavimentazione Teydeck Classic è un materiale composito ad alta densità composto da fibra di bamboo riciclata, polietilene alta densità e resine di coesione.

Necessità di minima manutenzione, non si scheggia, non si fessura, resiste alle rotture e alle deformazioni, è resistente in modo naturale a parassiti, funghi e batteri.

Per sistemi di posa vedi pagina 158.

Per scheda tecnica vedi pagina 132.

Teydeck Classic flooring is a high density composite material made up of recycled bamboo fibre, high density polyethylene and bonding resins. It requires minimal maintenance, it does not splinter or crack, resists breakage and deformation and is naturally resistant to parasites, fungi and bacteria.

For installation systems and data sheet, ask our technical office.

Inviateci il DWG con le misure del vostro ambiente. Il nostro ufficio tecnico vi svilupperà il disegno ed il preventivo.



Send us the DWG with measurements of your space. Our technical department will develop a design and a budget for you.



EWP3233

DOUBLE-FACE
Grigio Chiaro
Light Grey



EWP3233



EWP3234

DOUBLE-FACE
Grigio / Grey



EWP3234



FACILE INSTALLAZIONE
EASY INSTALLATION



RESISTENTE AGLI URTI
IMPACT RESISTANT



RESISTENTE RAGGI UV
UV RESISTANT



IMPERMEABILE
WATERPROOF



Pavimentazioni da esterno WPC classic

WPC CLASSIC OUTDOOR FLOORING

Inviateci il DWG con le misure del vostro ambiente.
Il nostro ufficio tecnico vi svilupperà il disegno ed il preventivo.
Send us the DWG with measurements of your space.
Our technical department will develop a design and a budget for you.



Teydeck classic



EWP3235

DOUBLE-FACE
Teak



EWP3235



EWP3236

DOUBLE-FACE
Mix color



EWP3236



Montaggio
pavimenti esterni.
Assembly
exterior flooring.



FACILE INSTALLAZIONE
EASY INSTALLATION



IMPERMEABILE
WATERPROOF



RESISTENTE RAGGI UV
UV RESISTANT



RESISTENTE AGLI URTI
IMPACT RESISTANT



Caratteristiche / Technical features Teydeck classic

Composizione Composition:	60% fibra di bamboo / 30% materiale plastico / 10% additivi chimici 60% bamboo fiber / 30% plastic material / 10% additives chemists
Peso totale: Total weight:	19,50 Kg al mq 19.50 kg per sq m
Spessore: Thickness:	23 mm ± 10%
Dimensioni: Size:	220 x 14,6 cm
Confezioni: Packages:	4 plance corrispondenti a 1,285 mq 4 planks corresponding to 1.285 m2



Pavimentazioni da esterno WPC protect

WPC PROTECT OUTDOOR FLOORING

TEYDECK PROTECT

La pavimentazione Teydeck Protect, aggiunge alle caratteristiche del Classic un rivestimento in PVC che rende il prodotto ancora più gradevole esteticamente, resistente alle macchie e con una manutenzione ridotta al minimo.

Per sistemi di posa vedi pagina 158.
Per scheda tecnica vedi pagina 136.

Inviateci il DWG con le misure del vostro ambiente. Il nostro ufficio tecnico vi svilupperà il disegno ed il preventivo.



TEYDECK PROTECT

The Teydeck Protect flooring adds a PVC coating to the characteristics of the Classic which makes the product even more aesthetically pleasing, resistant to stains and with minimal maintenance.

For installation systems and data sheet, ask our technical office.

Send us the DWG with measurements of your space. Our technical department will develop a design and a budget for you.



EWP3314

DOUBLE-FACE
Teak



EWP3314



EWP3315

DOUBLE-FACE
Antique



EWP3315



FACILE INSTALLAZIONE
EASY INSTALLATION



RESISTENTE AGLI URTI
IMPACT RESISTANT



RESISTENTE RAGGI UV
UV RESISTANT



IMPERMEABILE
WATERPROOF



Pavimentazioni da esterno WPC protect

WPC OUTDOOR FLOOR COVERINGS

Inviateci il DWG con le misure del vostro ambiente.
Il nostro ufficio tecnico vi svilupperà il disegno ed il preventivo.
Send us the DWG with measurements of your space.
Our technical department will develop a design and a budget for you.



Teydeck protect



EWP3316

DOUBLE-FACE
Faggio / Beech



EWP3316



EWP3317

DOUBLE-FACE
Grigio Chiaro
Light Grey



EWP3317



SISTEMA DI POSA
INSTALLATION SYSTEM
Pag. 000



ACCESSORI MONTAGGIO
MOUNTING ACCESSORIES
PAG. 000

Caratteristiche Teydeck WPC Protect pavimento da esterno Features Teydeck WPC Protect outdoor flooring

Composizione Composition:	60% fibra di bamboo / 30% materiale plastico / 10% additivi chimici 60% bamboo fiber / 30% plastic material / 10% additives chemists
Peso totale: Total weight:	19,50 Kg al mq 19.50 kg per sq m
Spessore: Thickness:	23 mm ± 10%
Dimensioni: Size:	220 x 14 cm
Confezioni: Packages:	4 plance corrispondenti a 1,232 mq 4 planks corresponding to 1.232 m2

For the technical datasheet in english, ask our office.



FACILE INSTALLAZIONE
EASY INSTALLATION



RESISTENTE AGLI URTI
IMPACT RESISTANT



RESISTENTE RAGGI UV
UV RESISTANT



IMPERMEABILE
WATERPROOF



PROFILI E ACCESSORI WPC - WPC PROFILES AND ACCESSORIES

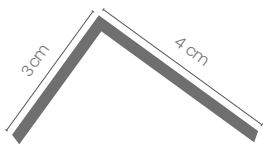

PROFILO AD "L" - Dimensioni: 2,20 m / "L" profile - Dimensions: 2,20 m

CLASSIC



EWP3267



EWP3268



EWP3270



EWP3269

PROTECT



EWP3318



EWP33319



EWP3320



EWP3321



EWP3266
Megatello / Megatello
Dimensioni / Size: 2,20 m



EWP3264
Clip fissaggio classic
Clip fissaggio classic



EWP3265
Clip partenza
Clip partenza



EWP3352
Clip di fissaggio protect
Clip di fissaggio protect

Prato sintetico

Per applicazioni interne ed esterne
Synthetic lawn for applications internal and external

 **COLLANTE DEDICATO**
DEDICATED GLUE
COL3096

Vedi pagina / See page 143





Prato sintetico / *Synthetic lawn*



PS450 1x25 m
PS451 2x25 m

Composizione: 100% fibra polipropilenica
Supporto di coesione: lattice drenante
Altezza pelo: 7 mm ± 10%
Peso totale: 1050 gr/mq ± 10%
Dimensione rotolo: Altezza 1 - 2 m (vedi codice)
Impiego: Esposizioni, ambienti esterni ed interni, bordi piscine, uso nautico.

Composition: 100% polypropylene fiber
Bonding support: draining latex
Pile height: 7 mm ± 10%
Total weight: 1050 gr/m² ± 10%
Roll size: Height 1 - 2 m (see code)
Use: Exhibitions, outdoor environments and interiors, pool edges, nautical.

Erba Green (spessore / *thickness* 20 mm)



PS3156

Composizione: 100% fibra polipropilenica
Supporto di coesione: lattice drenante
Altezza pelo: 20 mm ± 10%
Peso totale: 1050 gr/mq ± 10%
Dimensione rotolo: Altezza 2 m
Impiego: Esposizioni, ambienti esterni ed interni, bordi piscine, uso nautico.

Composition: 100% polypropylene fiber
Bonding support: draining latex
Pile height: 20 mm ± 10%
Total weight: 1050 gr/m² ± 10%
Roll size: Height 2 m
Use: Exhibitions, outdoor environments and interiors, pool edges, nautical.

Erba Elegance (spessore / *thickness* 30 mm)



PS3263

Composizione: 100% fibra polipropilenica
Supporto di coesione: lattice drenante
Altezza pelo: 30 mm ± 10%
Peso totale: 2200 gr/mq ± 10%
Dimensione rotolo: Altezza 2 m - lunghezza 20 m
Impiego: Esposizioni, ambienti esterni ed interni, bordi piscine, uso nautico.

Composition: 100% polypropylene fiber
Bonding support: draining latex
Pile height: 30 mm ± 10%
Total weight: 2200 gr/m² ± 10%
Roll size: Height 2 m - length 20 m
Use: Exhibitions, outdoor environments and interiors, pool edges, nautical.

Erba Max (spessore / *thickness* 40 mm)



PS2449

Composizione: 100% fibra polipropilenica
Supporto di coesione: lattice drenante
Altezza pelo: 40 mm ± 10%
Peso totale: 3300 gr/mq ± 10%
Dimensione rotolo: Altezza 2 m - lunghezza 20 m
Impiego: Esposizioni, ambienti esterni ed interni, bordi piscine, uso nautico.

Composition: 100% polypropylene fiber
Bonding support: draining latex
Pile height: 40 mm ± 10%
Total weight: 3300 gr/m² ± 10%
Roll size: Height 2 m - length 20 m
Use: Exhibitions, outdoor environments and interiors, pool edges, nautical.



INQUADRA IL QR CODE
E PERSONALIZZA I TUOI AMBIENTI.

*FRAME THE QR CODE
AND CUSTOMIZE YOUR SPACES.*



Pavimenti da interno

In qualsiasi tipo di ambiente, sia domestico che lavorativo, la scelta dei pavimenti è sicuramente primaria. Questi donano all'aspetto generale degli spazi un'atmosfera specifica a seconda del materiale, del colore e della forma, proprio perché il pavimento è lo sfondo per tutti gli elementi di arredo. La nostra gamma comprende prodotti di ultima generazione realizzati con materiali tecnologicamente avanzati, che sono tutti tecnicamente performanti per il loro design, la facilità di posa e per la stabilità. La nuova collezione di pavimenti in SPC tutti con sottopavimento integrato con finiture ad effetto legno profonde e realistiche, dalla elevata resistenza al calpestio e adatti sia per uso residenziale che per commerciale intenso. Inoltre sono disponibili le classiche pavimentazioni LVT sia da incollaggio ad alta resistenza che autoadesive semplici e di immediata installazione.

Indoor floors

In any location, both domestic and commercial, the choice of flooring is certainly primary.

These give the general appearance of the spaces a specific atmosphere depending on the material, color and shape, precisely because the floor is the background for all the furnishing elements.

Our range includes latest generation products made up of technologically advanced materials, which are all technically performing due to their design, ease of installation and stability.

The new collection of SPC floors all with integrated sub-floor with deep and realistic wood effect finishes, with high resistance to foot traffic and suitable for both residential and intense commercial use. In addition, the classic LVT flooring is available both for high strength bonding and simple self adhesive and immediate installation.



Teystrong plus AC5

Listoni e Piastrelle / Planks and Tiles

Teystrong listone incastro Rigid Core (Pavimento SPC spessore 5,5 mm AC5)

SPC ad incastro Rigid Core. Nuova collezione di pavimenti di ultima generazione a struttura rinforzata con fibra minerale. La nuova composizione rende il pavimento più stabile e resistente alle escursioni termiche a ridotto coefficiente di dilatazione e con una tolleranza maggiore delle imperfezioni dei pavimenti preesistenti (fughe ceramiche). Velocità di montaggio, resistenza all'abrasione e grande stabilità alla dilatazione termica, ne fanno il pavimento ideale per locali di grandi dimensioni ed alta calpestabilità.

Per sistemi di posa vedi pagina 159.

Teystrong Rigid Core Interlocking Plank (AC5 5,5 mm thickness SPC floor)

Rigid Core Interlocking SPC. New collection of state-of-the-art floors with a structure reinforced with mineral fibres. The new composition makes the floor more stable and resistant to thermal excursions with a reduced coefficient of expansion and with greater tolerance of the imperfections of the pre-existing floors (ceramic joints). Fast assembly, resistance to abrasion and great stability to thermal expansion, this is the ideal floor for large rooms and high traffic areas.

For installation systems and data sheet, ask our technical office.

Caratteristiche / Features	Teystrong Plus AC5 SPC da incastro / Interlocking
Composizione / Composition:	PVC eterogeneo + fibra minerale / Heterogeneous PVC + mineral fibre
Spessore / Thickness:	5,5 mm (4 mm + 1,5 mm di sottopavimento) / 5,5 mm (4 mm + 1,5 underfloor)
Strato di usura / Wear layer:	0,55 mm
Listone / Plank - Listone XL / XL Plank:	18,3 x 121,92 cm - 22,83 x 121,92 cm XL
Piastrelle / Tiles:	30,5 x 61 cm
Confezioni / Packages:	1 scatola contiene 10 listoni equivalenti a 2,24 mq 1 box contains 10 planks equivalent to 2.24 sqm
	1 scatola contiene 8 listoni XL equivalenti a 2,23 mq 1 box contains 8 XL planks equivalent to 2.23 sqm
	1 scatola contiene 12 piastrelle equivalenti a 2,23 mq 1 box contains 12 tiles equivalent to 2.23 sqm
Pancale / Pallet:	Listone / Plank 134,4 mq - Listone XL / XL Plank 115,96 mq
	Piastrelle / Tiles 115,96 mq



STRUTTURA DEL TEYSTRONG / TEYSTRONG'S STRUCTURE



- + Pratico: sottopavimento integrato
- + Resistente: SPC minerale alta resistenza
- + Economico: posa veloce Fai da Te
- + Practical: integrated underfloor
- + Resistant: High strength mineral spc
- + Economical: quick laying DIY



PVCS3310



PVCS3597



PVCS3598



PVCS3596



Teystrong plus AC5

Per sistemi di posa vedi pagina 159.

Per scheda tecnica vedi pagina 142.

For installation systems and data sheet, ask our technical office.



PVCS3302 - Plancia / Plank XL



PVCS3303 - Plancia / Plank XL

Per sistemi di posa vedi pagina 159.

Per scheda tecnica vedi pagina 142.

For installation systems and data sheet, ask our technical office.

Piastrelle / Tiles



PVCS3304



PVCS3305



Teystrong plus AC4

(Pavimento SPC con sottopavimento integrato, spessore 5,5 mm AC4)

Pavimento vinilico di ultima generazione con fibra minerale. La nuova composizione lo rende più stabile, resistente alle escursioni termiche e con una tolleranza maggiore alle imperfezioni del pavimento (ridotto effetto "telegrafo"). Alta resistenza al calpestio e posa rapida grazie al sotto-pavimento integrato, che lo rende un pavimento versatile ed economico.

Per sistemi di posa vedi pagina 159.

(SPC floor with integrated underfloor, thickness 5.5 mm AC4)

Latest generation vinyl floor with mineral fiber. The new composition makes it more stable, resistant to temperature changes and with a greater tolerance to floor imperfections (reduced "telegraph" effect). High walking resistance and quick laying thanks to the integrated sub-floor, which makes it a versatile and economical floor.

For installation systems and data sheet, ask our technical office.

Caratteristiche / Features	Teystrong Plus
Composizione / Composition:	PVC eterogeneo + fibre minerali / Heterogeneous PVC + mineral fibres
Spessore / Thickness:	5,5 mm (4mm+1,5mm di sottopavimento) / 5.5 mm (4mm+1.5mm underfloor)
Strato di usura / Wear layer:	0,40 mm
Listone / Plank - Listone XL / XL Plank:	18,3 x 121,92 cm - 22,83 x 121,92 cm XL
Confezioni / Packages:	1 scatola contiene 10 listoni equivalenti a 2,24 mq / 1 box contains 10 planks equivalent to 2.24 sqm 1 scatola contiene 8 listoni XL equivalenti a 2,24 mq / 1 box contains 8 XL planks equivalent to 2.24 sqm
Pancale / Pallet:	Listone / Plank 134,4 mq Listone XL / XL Plank 115,96 mq



AC4-ISO 10874



IGNIFUGO
CLASSE BFL
S1 EN 9239



E1
HCHO
EMISSIONE
FORMALDEIDE



RESISTENZA UV
ISO 105 B02



ANTISCIVOLO



RESISTENZA
AGENTI CHIMICI
EN 423



PVCS3595



PVCS3307



PVCS3592



PVCS3593



PVCS3599

Teystrong plus AC4

Per sistemi di posa vedi pagina 159.

Per scheda tecnica vedi pagina 146.

For installation systems and data sheet, ask our technical office.



PVCS3306



PVCS3309





Per sistemi di posa vedi pagina 159.
Per scheda tecnica vedi pagina 146.
For installation systems and data sheet, ask our technical office.



PVCS3340 XL

LVT da incollaggio

LVT da incollaggio spessore 2,5mm con strato di usura da 0,55, lo rendono un pavimento estremamente versatile. Utilizzabile sia per usi professionali e locali ad alto traffico, sia per uso residenziale. Una gamma di colori attuali e di tendenza fanno della pavimentazione Teydry uno strumento adatto ad ogni esigenza sia residenziale che professionale. L'installazione con il sottopavimento Teysafe Rapid rende tutte le operazioni di montaggio estremamente veloci e pulite.

Per sistemi di posa vedi pagina 159.

LVT for bonding

2.5 mm thick glued LVT with a 0.55 wear layer, makes it an extremely versatile floor. It can be used both for professional uses with high traffic areas, and for residential use. A range of current and trendy colors make Teydry flooring suitable for all residential and professional needs. Installation with the Teysafe Rapid underlay makes every assembly operations extremely fast and clean.

For installation systems and data sheet, ask our technical office.

Caratteristiche	Teydry AC5 LVT da incollaggio
Composizione:	PVC eterogeneo
Spessore:	2,5 mm
Strato di usura:	0,55 mm
Dimensione:	Listone: 22,86x121,92 cm Piastrina: 30,48x60,96 cm
Confezione:	Listone: 14 Pz equivalenti a 3,90 mq Piastrina: 20 Pz equivalenti a 3,72 mq



ISO 10874



ISO 10874



IGNIFUGO CLASSE BFL S1 EN 131501



ANTISCIVOLO DIN 51130



ISO 150/B02 ≥ 6



EN 1815 ≥ 6 KV



EMISSIONE FORMALDEIDE



RESISTENZA AGENTI CHIMICI EN 423



RESISTENZA UV ISO 105 B02



PVC3275



PVC3276



PVC3277



PVC3279



Piastrelle / Tiles



PVC3272



PVC3283

Per sistemi di posa vedi pagina 159.

Per scheda tecnica vedi pagina 150.

For installation systems and data sheet, ask our technical office.



Listone LTV autoadesivo (spessore 2 mm)

Listone in PVC autoadesivo per uso interno residenziale perfetto per ristrutturazioni. Decorì legno e piastrelle incredibilmente realistici e di effetto. Installare su sottofondo solido e perfettamente livellato è necessario l'utilizzo di sottopavimento indicato.

Per sistemi di posa vedi pagina 159.

Self-adhesive LTV strip (thickness 2 mm)

Self-adhesive PVC strip for residential interior use perfect for renovations. Decorate wood and tiles incredibly realistic and effect. Install on solid and perfectly leveled subfloor it is necessary to use indicated underfloor.

For installation systems and data sheet, ask our technical office.

Caratteristiche	Teyself LVT autoadesivo
Composizione:	PVC eterogeneo
Spessore:	2 mm ± 10%
Strato di usura:	0,15 mm
Dimensione listone:	Listone: 15,24 x 91,44 cm Piastrella: 30,48 x 60,96 cm
Confezioni:	Listone: 1 scatola contiene 24 listoni equivalenti a 3,345 mq Piastrella: 24 pezzi equivalenti a 4,459 mq



EN 14041



RESISTENZA UV
ISO 105 B02



ANTISCIVOLO



E1
HCHO
EMISSIONE
FORMALDEIDE



IGNIFUGO
CLASSE BFL S1 EN 9239



PVC2479



PVC3282



PVC2478



PVC1148

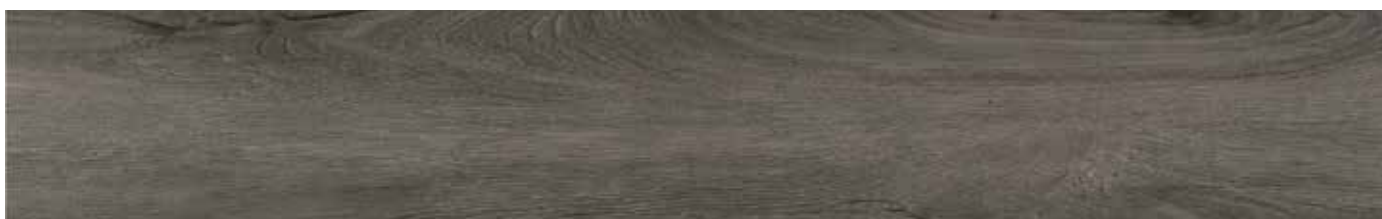

PVC2480



PVC2482



PVC2481



PVC3168



PVC1147

Per sistemi di posa vedi pagina 159. | *For installation systems and data sheet,*
Per scheda tecnica vedi pagina 153. | *ask our technical office.*



Sottopavimenti e accessori

SUBFLOORS AND ACCESSORIES

Profili in alluminio per LVT / Aluminium Profiles for LVT



Barra: 2,7 m Confezione: 1 pz

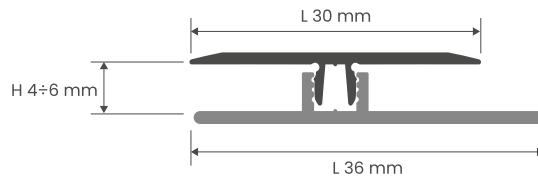

PL3016



PL3015



Barra: 2,7 m Confezione: 1 pz

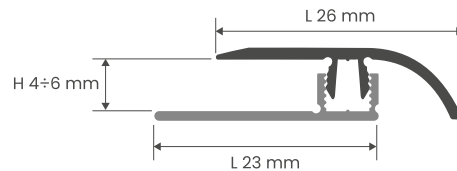

PL3018



PL3017

Profili in alluminio per Laminato / Profiles in aluminium for Laminate

Rivestiti nei colori sottostanti / Coated in the colours below



PL3350 Barra: 2,7 m
Confezione: 1 pz

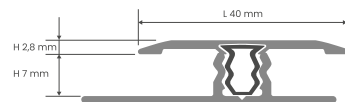

PL3351 Barra: 2,7 m
Confezione: 1 pz



Alluminio



Oro

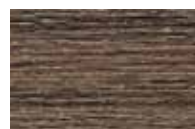

Olmo Grigio



Rovere Bianco



Rovere Chiaro



Rovere Decapè



Rovere Ghiaccio



Rovere Grigio



Rovere Segato



Rovere Victoria



Teak Indonesia



Zebano

Sottopavimento acusticamente isolante per la posa di laminati Soundproofing underfloor for laying laminates



IM853

Spessore: 3 mm
Dimensione rotolo:
h 100 cm, l 100 m

Thickness: 3 mm
Roll size:
h 100 cm, l 100 m



IM852

Spessore: 2 mm
Dimensione rotolo:
h 100 cm, l 100 m

Thickness: 2 mm
Roll size:
h 100 cm, l 100 m



IM2530

Spessore: 2 mm
Dimensione rotolo:
h 100 cm, l 50 m

Thickness: 2 mm
Roll size:
h 100 cm, l 50 m



IM3218 Teysafe Thermo per laminato

Materiale: XPS
 T spessore: 1,6 mm
 L lunghezza: 15000 mm
 W larghezza: 1100 mm
 QW densità: 45 kg/m³
 Confezione: 20 m²
 Sul bancale: 660 m²

PARAMETRI



RISCALDAMENTO
 A PAVIMENTO**



ISOLAMENTO TERMICO
 Fino a 0,05 m²k/W



COMFORT ACUSTICO
 Fino a 14%



COMFORT ACUSTICO
 Fino a 18 dB



DURABILITÀ DEL PAVIMENTO
 Fino a 90 kPa



DURABILITÀ DEL PAVIMENTO
 Fino a 0,8 mm



IM3219 Teysafe Acquastop per laminato

Materiale: XPS / PET
 T spessore: 2 mm
 L lunghezza: 13640 mm
 W larghezza: 1100 mm
 QW densità: 32 kg/m³
 Confezione: 15 m²
 Sul bancale: 600 m²

PARAMETRI



ISOLAMENTO TERMICO
 Fino a 0,08 m²k/W



COMFORT ACUSTICO
 Fino a 14%



COMFORT ACUSTICO
 Fino a 20 dB



DURABILITÀ
 DEL PAVIMENTO
 Fino a 90 kPa



DURABILITÀ DEL PAVIMENTO
 Fino a 1,0 mm



BASE
 150

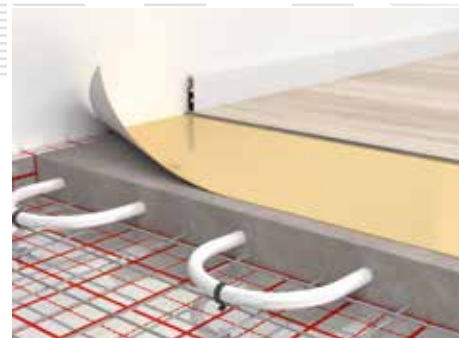

IM3221 Teysafe LVT Professional

Materiale: PU / minerali + Vello
 T spessore: 1,6 mm
 L lunghezza: 8500 mm
 W larghezza: 1000 mm
 QW densità: 1000 kg/m³
 Confezione: 8,5 m²
 Sul bancale: 340 m²

PARAMETRI



RISCALDAMENTO
 A PAVIMENTO



ISOLAMENTO TERMICO
 Fino a 0,008 m²k/W



COMFORT ACUSTICO
 Fino a 8 %



COMFORT ACUSTICO
 Fino a 16 dB



DURABILITÀ DEL PAVIMENTO
 Fino a 400 kPa



DURABILITÀ DEL PAVIMENTO
 Fino a 0,5 mm



IM3222 Teysafe LVT Smart

Materiale: modificato XPS / PET
 T spessore: 1,5 mm
 L lunghezza: 8500 mm
 W larghezza: 1180 mm
 QW densità: 100 kg/m²
 Confezione: 10 m²
 Sul bancale: 420 m²

PARAMETRI



RISCALDAMENTO
 A PAVIMENTO



ISOLAMENTO TERMICO
 Fino a 0,04 m²k/W



COMFORT ACUSTICO
 Fino a 19 dB



DURABILITÀ
 DEL PAVIMENTO
 Fino a 400 kPa



DURABILITÀ
 DEL PAVIMENTO
 Fino a 1 mm



BASE
 150



IM3224 Teysafe Rapid

Materiale: PU / minerali + Vello
 T spessore: 1,8 mm
 L lunghezza: 6000 mm
 W larghezza: 1000 mm
 QW densità: 1000 kg/m³
 Confezione: 6 m²
 Sul bancale: 240 m²

PARAMETRI



RISCALDAMENTO
 A PAVIMENTO



ISOLAMENTO TERMICO
 Fino a 0,01 m²k/W



COMFORT ACUSTICO
 Fino a 8%



COMFORT ACUSTICO
 Fino a 17 dB



DURABILITÀ
 DEL PAVIMENTO
 Fino a 400 kPa



DURABILITÀ
 DEL PAVIMENTO
 Fino a 0,6 mm



BASE
 75

Sistemi di posa

LAYING SYSTEMS

For installation systems in English, ask our office.



Sistemi di posa.
Laying systems.

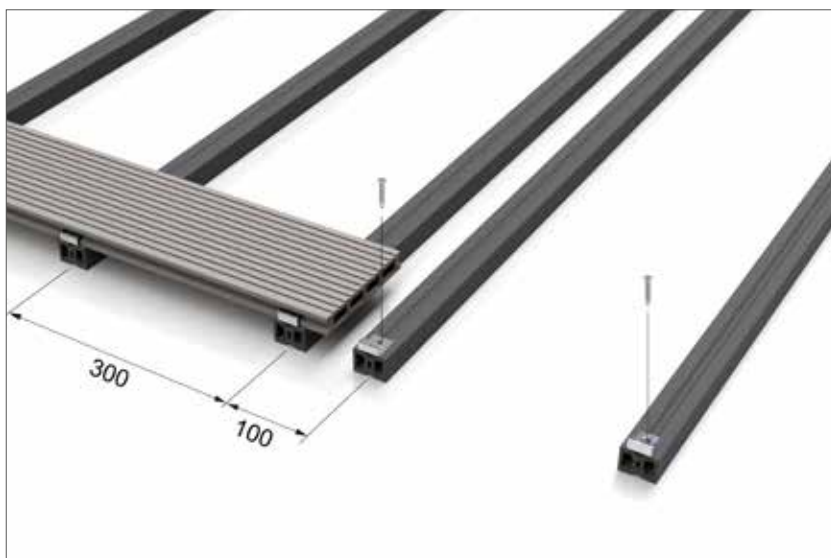

TEYDECK

Per il montaggio si consiglia di seguire pochi semplici passi:

- 1 - Nel giunto tra due elementi consecutivi, devono essere previsti 2 magatelli di appoggio, ciascuno all'estremità di ogni plancia
- 2 - La distanza tra due magatelli deve essere di circa 25-30 cm.
- 3 - Lungo i bordi della pavimentazione dove essere installato un apposito profilo a L. Prima di ogni installazione rendere il pavimento asciutto, pulito e livellato. Si prega di chiedere opportune informazioni ad esperti specializzati per l'installazione. Si ricorda che la pavimentazione WPC non ha funzioni strutturali ma costituisce un elemento di rivestimento e rifinitura.

Dato un tasso di assorbimento dell'acqua di circa lo 0,2% e un tasso di dilatazione di circa lo 0,5%, si consiglia un gap di almeno 5/6 mm tra due plance consecutive per consentire la possibile espansione o contrazione della stessa. Inclinare leggermente il piano di calpestio per consentire il deflusso dell'acqua.

Disporre correttamente i magatelli sulla pavimentazione in calcestruzzo. Si consiglia di disporli ad un interasse di 25/30 cm. Mantenere una distanza di 5 mm tra le testate di due magatelli consecutivi. In base alle condizioni di installazione si suggeriscono due possibili metodi a cui poter far riferimento:

- 1 - I fori da realizzare con il trapano elettrico sui magatelli devono essere più piccoli del diametro della vite, quindi fissare i magatelli sulla pavimentazione in cemento con viti e tasselli a pressione.

Si prega di garantire la planarità dei supporti di appoggio delle plance quindi non lasciare in rilievo la testa delle viti;

- 2 - Incollare i magatelli al piano in calcestruzzo e riempire gli interstizi con il cemento.

Fissare per ogni magatello le apposite piastrine di partenza in acciaio inox.

Posizionare la prima plancia lungo il bordo scanalato.

Disporre le fila successiva di clip in acciaio sui profili. Inserire una nuova fila di plance e proseguire fino ad ultimare.

La scanalatura tra due plance dovrebbe essere fissata mediante le clip in acciaio. Spingere la plancia dal lato opposto e avvitare le viti all'interno dei fori di ogni clips.

Considerando una superficie da montare di 4,4 x 4,4 m (mq.19,36), gli accessori necessari sono i seguenti:

Clips fissaggio 500 pz. (25 pz mq) - Clips partenza 26 pz. (3 pz mt) - Magatelli 63,8 m (3,5 m mq).

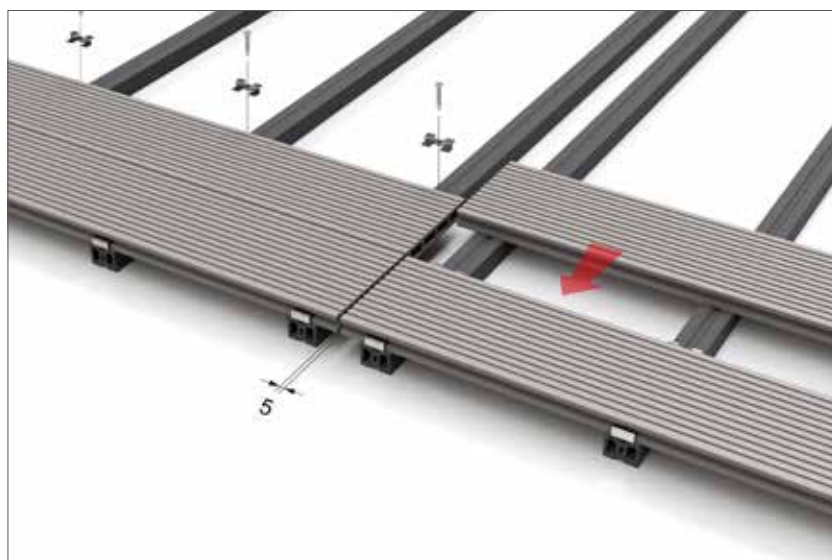

TEYSTRONG PLUS AC4 AC5

La posa è estremamente semplice e veloce. Grazie alla nuova formulazione con polvere di pietra e al sottopavimento integrato il pavimento Teystrong Plus può essere montato su pavimenti pre-esistenti con fughe planari fino ad 1 cm di larghezza. Fare ambientare il pavimento per 48 ore ad una temperatura non inferiore a 18 gradi e non superiore a 30 gradi. Pulire il pavimento da tutta la sporcizia ed i detriti e livellare eventuali dislivelli. Lasciare sul perimetro e in corrispondenza di ogni ostacolo 1 cm di spazio. Se il tratto supera gli 8-10 mt è consigliabile inserire un giunto di dilatazione. Non è necessario l'utilizzo di collanti. Il sistema a click garantisce una posa facile e rapida.



TEYDRY AC5

Per la pavimentazione Teydry si possono utilizzare due tipologie di montaggio.

- 1 - Con l'utilizzo di colla, della tipologia necessaria in base al sottofondo, è necessario che il sottofondo sia perfettamente preparato, asciutto, stabile e perfettamente livellato.
- 2 - Con materassino Teysafe Rapid che permette un montaggio estremamente più veloce, pulito e garantito. Anche in questo caso il sottofondo deve essere livellato perfettamente ed esente da difetti.



TEYSELF

La pavimentazione Teyself è perfetta per i montaggi fai da te. Non necessita di manodopera specializzata in quanto già provvisto di collante. Il pavimento dove andremo ad installarlo dovrà essere pulito, levigato, sgrassato e privo di imperfezioni e perfettamente planare (fughe, crepe, avvallamenti devono essere livellati prima dell'installazione). Prima della posa in opera far ambientare il prodotto per almeno 24 ore nell'ambiente dove dovrà essere installato. Il range di temperatura per l'installazione è da un minimo di 18° ad un massimo di 28°. Per una maggiore garanzia è consigliato l'utilizzo di uno strato di colla idonea aggiuntiva per superfici superiori ai 15/16 mq. Non è consigliata l'installazione su superfici con riscaldamento a pavimento, su tutti i pavimenti la cui superficie sia eccessivamente calda/fredda, su pannelli in truciolare, su locali eccessivamente umidi, all'esterno. Una volta installato per la manutenzione non usare prodotti abrasivi, rimuovere lo sporco usando aspirapolvere e uno straccio bagnato, usare prodotti neutri e utilizzare protezioni per gambe di tavoli e sedie.





Polistirolo

Nel corso degli anni il polistirolo è stato utilizzato per un crescente numero di elementi architettonici e arredi personalizzati. Dai contro soffitti si è passati ai pannelli per gli isolamenti termici fino a cornici, lesene, rosoni, colonne, capitelli ed elementi di ogni genere e forma. Questi prodotti danno la possibilità di scegliere un articolo che risulti identico alle tradizionali opere in muratura, oppure adottare nuove forme e colori, dando respiro ad avanzate proposte di design. Resistenza, facilità e velocità di installazione, semplicità nella demolizione e sostituzione, rendono questo materiale adatto alla progettazione d'interni di ogni tipo, dallo stile classico al contemporaneo.

Polistirolo

Over the years polystyrene has been used for a increasing number of architectural elements and custom furnishings. From the false ceilings we have passed to panels for thermal insulation up to frames, pilasters, rose windows, columns, capitals and elements of all kinds and shapes. These products give the opportunity to choose an article that is identical to traditional masonry, or adopt new shapes and colors, giving scope to advanced design proposals. Strength, ease and speed of installation, simplicity in demolition and replacement, make this material suitable for interior design of all kinds, from classic to contemporary style.

Cornici estruse / Extruded frames

Profili per illuminazione LED / Profiles for LED lighting

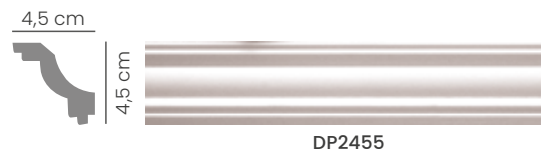
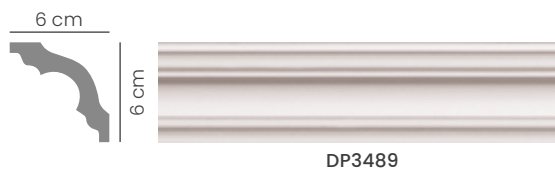
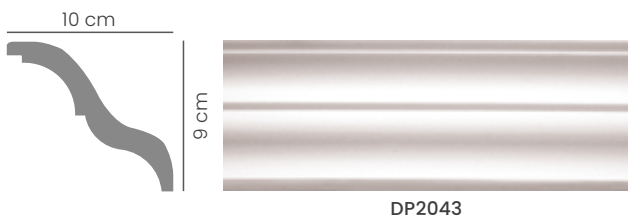

Collanti dedicati. Per quantità vedi listino.
Dedicated glues. For quantity see price list.
COL3589 - COL3590 - COL1554
COL3591 (sigillante / sealant)

Vedi pagine
collanti
See gluing pages
176 - 177 - 178



FACILE INSTALLAZIONE
EASY INSTALLATION



VERNICIABILE
PAINTABLE



IMPERMEABILE
WATERPROOF



DP2031



DP2048



DP2038



DP2045



DP3486



DP2326



DP3492

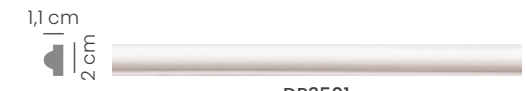

DP3501



DP2033



DP2450



DP2327

Elemento coordinato con art. DP2326



DP3488

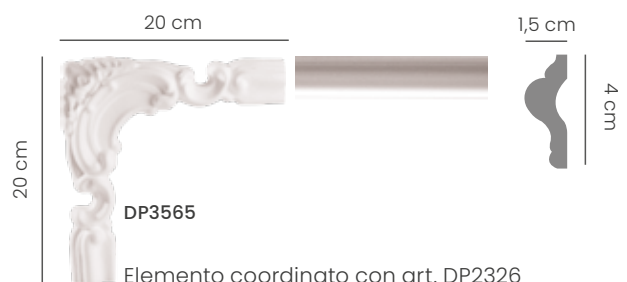

DP3565

Elemento coordinato con art. DP2326



DP2040



DP3491



DP2451



DP2041



DP2044



DP2325

Elemento coordinato con art. DP2045



DP2039





DP3500

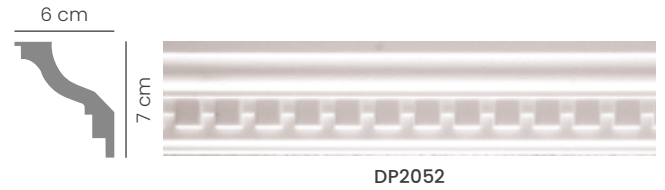

DP3487

Cornici decorate / Decorated frames



 collanti dedicati. Per quantità vedi listino.
Dedicated glues. For quantity see price list.
COL3589 - COL3590 - COL1554
COL3591 (sigillante / sealant)

Vedi pagine collanti
See gluing pages
176 - 177 - 178



FACILE INSTALLAZIONE
EASY INSTALLATION



VERNICIABILE
PAINTABLE



IMPERMEABILE
WATERPROOF

Rosoni / Ceiling rosettes



DP2064 | Ø 41 cm



DP2063 | Ø 33 cm

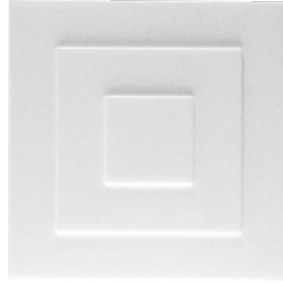

DP2462 | 32X32 cm



DP2061 | Ø 31 cm



DP2330 | Ø 28 cm



DP2060 | Ø 21 cm



DP2067 | Ø 53 cm



DP2331 | Ø 42 cm

Mensole / Corbels



DP2335
L 19,5 x H 20 x P 10 cm



DP2334
L 12 x H 17 x P 7 cm





Lesene e Semicolonne
Pilastres and Half-columns



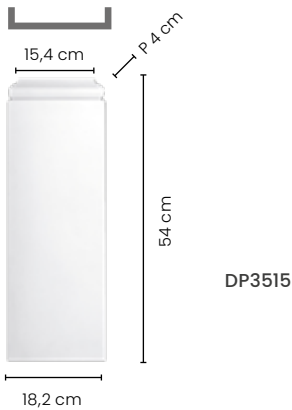
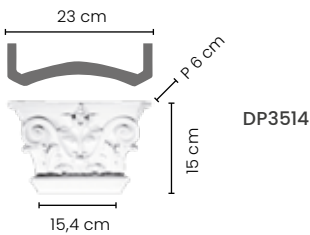
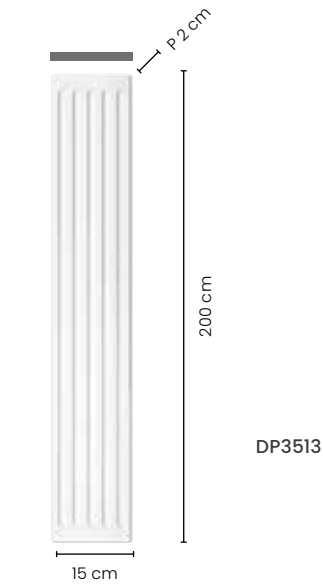
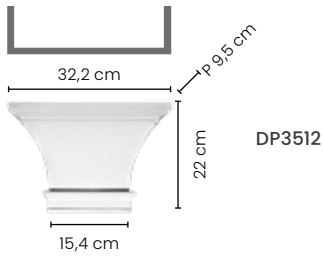

Esempi di composizioni
Examples of compositions

Lesene resistenti alla pressione / *Pilastres resistant to pressure*

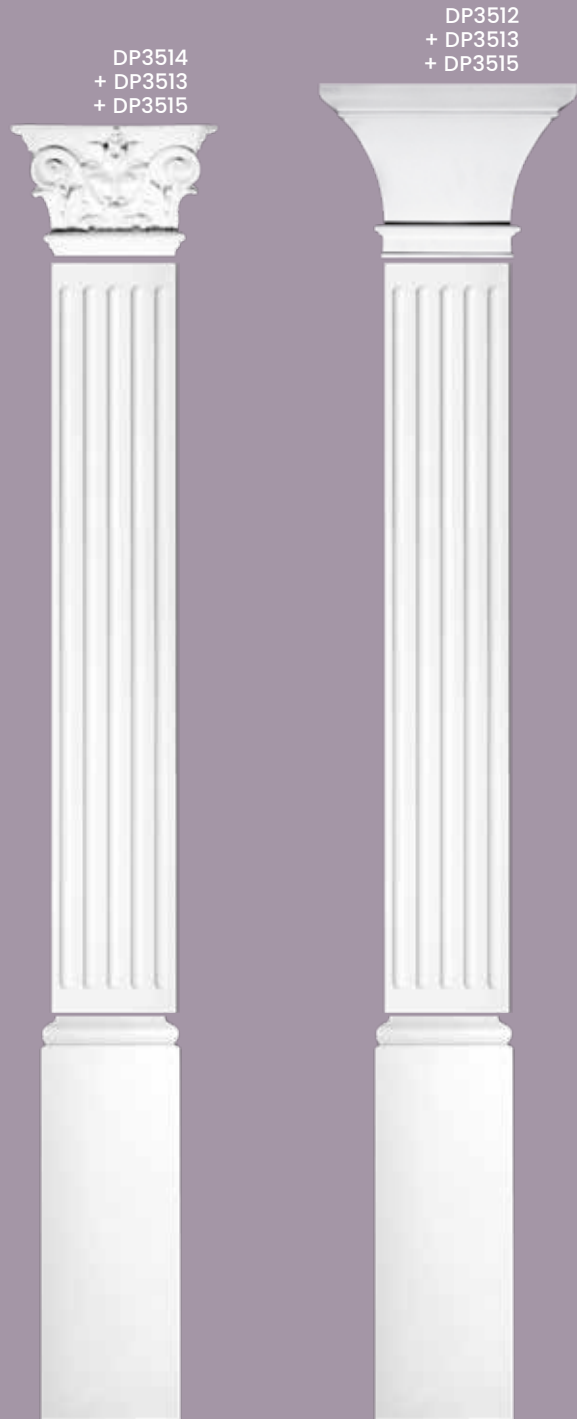

Esempi di composizioni
Examples of compositions



 collanti dedicati. Per quantità vedi listino.
Dedicated glues. For quantity see price list.
COL3589 - COL3590 - COL1554
COL3591 (sigillante / sealant)

Vedi pagine
collanti
See gluing pages
176 - 177 - 178



FACILE INSTALLAZIONE
EASY INSTALLATION



VERNICIABILE
PAINTABLE



IMPERMEABILE
WATERPROOF

Semicolonne / Semicapitelli / Semibasi resistenti alla pressione
Semi-columns, Semi-capitals, Pressure-resistant semi-bases

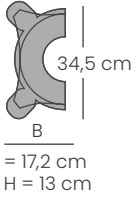

DP3516

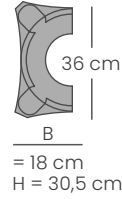

DP3520



Semicapitello composto da due parti da montare.
Compound semi-capital two parts to be mounted.

Semicapitello composto da due parti da montare.
Compound semi-capital two parts to be mounted.



DP3519



DP3517

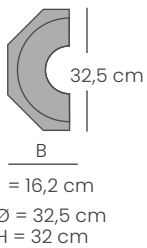

DP3521

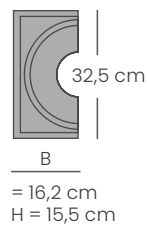

DP3518

Pannelli in polistirene espanso per soffitti / Expanded polystyrene ceiling panels



DP3558
50x50 cm



DP3557
50x50 cm



DP3559
50x50 cm

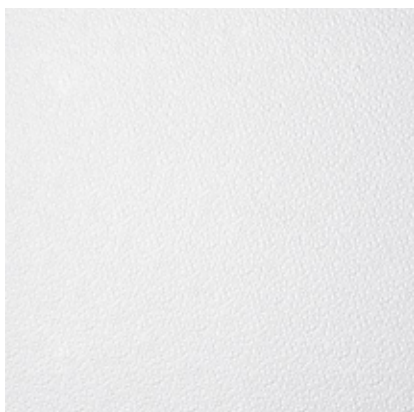

DP3560
50x50 cm

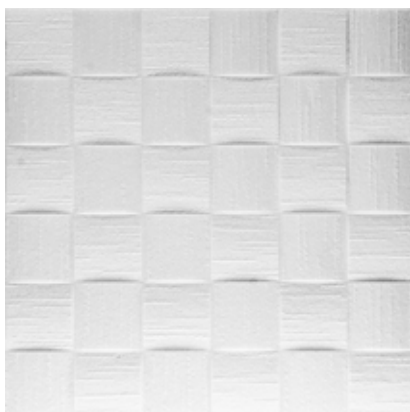

DP3561
50x50 cm



DP3562
50x50 cm



DP3563
50x50 cm



DP3564
50x50 cm

Per tutti gli articoli presenti in questa pagina, la quantità necessaria per 100 mq è di 13 cartucce collante **TEYSIL PRO**.

*For all the items on this page, the required amount for 100 sqm is 13 **TEYSIL PRO** adhesive cartridges.*

 collanti dedicati. Per quantità vedi listino. Dedicated glues. For quantity see price list.
COL3589 - COL3590 - COL1554
COL3591 (sigillante / sealant)

Vedi pagine collanti See gluing pages 176 - 177 - 178



FACILE INSTALLAZIONE
EASY INSTALLATION



VERNICIABILE
PAINTABLE



IMPERMEABILE
WATERPROOF

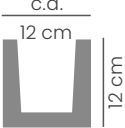
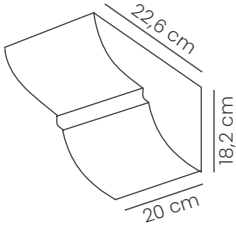

Travi e mensole in poliuretano con finitura legno
Polyurethane beams and shelves with wood finish

	 <p>DP2345 lunghezza 4 m</p>	 <p>DP2346 lunghezza 4 m</p>	 <p>DP2347 lunghezza 4 m</p>
 <p>Mensola per travi misura:</p>	<p>Mensola abbinata DP2349</p> 	<p>Mensola abbinata DP2350</p> 	<p>Mensola abbinata DP2351</p> 
	 <p>DP2352 lunghezza 2,60 m</p>		
 <p>Staffa in PVC</p>	<p>DP2353 lunghezza 1 m</p>		

 collanti dedicati. Per quantità vedi listino.
 Dedicated glues. For quantity see price list.
 COL3589 - COL3590 - COL1554
 COL3591 (sigillante / sealant)

Vedi pagine
 collanti
 See gluing pages
 176 - 177 - 178



FACILE INSTALLAZIONE
 EASY INSTALLATION



VERNICIABILE
 PAINTABLE



IMPERMEABILE
 WATERPROOF

Isolanti / Insulating



DP2708

Spessore / Thickness:	4 mm ± 10%
Dimensione rotolo / Roll size:	h 50 cm - L 5 m
Confezioni / Packages:	2,50 mq



DP2709

Spessore / Thickness:	4 mm ± 10%
Dimensione foglio / Sheet size:	100 x 50 cm
Confezioni / Packages:	25 mq



Lastra isolante / Insulating sheet

Densità / Density:	35 kg/mc
Coefficiente conducibilità Coefficient of conductivity:	0,0273 kcal/mq.h °C
Coefficiente dilatazione termica Thermal expansion coefficient:	long 0,08 mm/m °C trasv. 0,06 mm/m °C
Assorbimento acqua Water absorption:	dopo /after 28 gg /days 0,05% Vol dopo /after 56 gg / days 0,06% Vol
Resistenza compressione Compressive strength:	0,15 N/mmq
Resistenza trazione Tensile strength:	0,18 N/mmq
Tempeatura limite di impiego Limit of use hardening:	-50°C + 80°C

È una lastra in polistirene espanso estruso ad alta densità, si applica su pareti all'interno delle abitazioni, protegge dal freddo, dall'umidità, dalle muffe e dal caldo.

Nelle vecchie abitazioni corregge le imperfezioni delle pareti come crepe, umidità ed altro; protegge inoltre i vostri mobili. Può essere tinteggiato o rivestito con tappezzeria.



DP2097
Estruso / Extruded
250x80x0,6 cm
Confezione / Package
20 mq

is a high density extruded polystyrene foam sheet, it is applied on walls inside homes, it protects from cold, moisture, mold and heat.

In old houses it corrects imperfections of the walls such as cracks, moisture and other; it also protects your furniture. It can be painted or upholstered.



Collanti

Dalla ricerca e la collaborazione con produttori altamente specializzati, Teykos by Colori in Casa ha realizzato una gamma di collanti specifici, sia da esterno che interno, pensati per tutte le varie tipologie di prodotti presenti in catalogo. Dagli adesivi per interni per ancoraggio senza l'utilizzo di chiodi, a quelli progettati per applicazioni di incollaggio elastico, con materiali di costruzione in settori industriali, automotive, trasporti e della marina.

Adhesives

From research and collaboration with highly specialized manufacturers, Teykos by Colori in Casa has created a range of specific adhesives, both indoor and outdoor, designed for all the various types of products in the catalog. From interior adhesives for anchoring without the use of nails, to those designed for elastic bonding applications, with construction materials in industrial, automotive, transport and marine sectors.



ADHESIVES



COL3589 Adesivo Teysil PRO Ideale per interni

Adesivo di montaggio acrilico in dispersione acquosa, adatto per l'incollaggio senza l'utilizzo di chiodi.

COL3589 Adhesive Teysil PRO Ideal for indoors

Adhesive for mounting acrylic in water dispersion, suitable for bonding without the use of nails.



Articolo/Article	Confezione/Packages	Attrezzatura/Equipment	Caratteristiche/Characteristics
COL3589	 405 g Scatola da 12 pezzi / Box of 12 pieces		

MODALITÀ D'USO:

le superfici devono essere pulite e asciutte, di cui una porosa e assorbente. Il fondo deve essere compatto. Applicare a punti o a cordoli, sia al centro che ai margini della superficie da incollare, poi far aderire e premere uniformemente. Può essere necessario (per superfici irregolari o carichi troppo pesanti) l'utilizzo di un sostegno fino a completo indurimento.

APPLICAZIONE:

da +5°C a +40°C. Scheda di sicurezza disponibile per utenti professionali. Scadenza e conservazione: 18 mesi dalla data di produzione. Conservare in luogo fresco e asciutto. Teme il gelo.

INCOLLA:

plastica, PVC, legno, polyforte, polistirolo, sughero, battiscopa, metallo, parquet, moquette, ceramica, pietre, mattoni.

Riservato ad utilizzatori professionali.

Smaltimento: seguire le direttive nazionali.

HOW TO USE IT:

the surfaces must be clean and dry, one of which is porous and absorbent. The bottom must be compact. Apply to stitches or curbs, both at the center and at the edges of the surface to be glued, then adhere and press uniformly. It may be necessary (for uneven surfaces or too heavy loads) to use a support until completely hardened.

APPLICATION:

+5 C to +40 C. Safety data sheet available for professional users. Shelf life: 18 months from the date of production. Store in a cool, dry place. Frost-free.

PASTE:

plastic, pvc, wood, polyforte, polystyrene, cork, baseboards, metal, parquet, carpet, ceramics, stones, bricks.

Reserved for professional users.

Disposal: follow national directives.



COL3590 Adesivo Teysil PRO Ideale per interni

Adesivo di montaggio acrilico in dispersione acquosa, adatto per l'incollaggio senza l'utilizzo di chiodi.

COL3590 Wall decal Teysil PRO Ideal for indoors

Adhesive for mounting acrylic in water dispersion, suitable for bonding without the use of nails.



Articolo/Article	Confezione/Packages	Attrezzatura/Equipment	Caratteristiche/Characteristics
COL3590	 2,5 kg 1 Pezzo 1 Piece		

COL3591 Sigillante adesivo Teysil SUPERTAK PRO

SILICONE SILANICO

Adesivo elastico a base di SMP - Silyl Modified Polymer. Progettato per applicazioni di incollaggio elastico con materiali generali di costruzione così come nei settori dell'industria, automotive, trasporti e della marina. Verniciabile.

CARATTERISTICHE:

specifico per pannelli PVC su fondi anche non assorbenti, incollaggio-sigillatura multimateriale su fondi assorbenti e non assorbenti.

INCOLLA:

plastica, PVC, legno, polyforte, polistirolo, sughero, battiscopa, metallo, parquet, moquette, ceramica, pietre, mattoni.

Riservato ad utilizzatori professionali.
Smaltimento: seguire le direttive nazionali.

COL3591 Adhesive sealant Teysil SUPERTAK PRO

SILANIC SILICONE

Elastic adhesive based on SMP - Silyl Modified Polymer. Designed for elastic bonding applications with general construction materials as well as in industry, automotive, transportation and marine. Paintable.

CHARACTERISTICS:

specific for PVC panels on surfaces also non-absorbent, multi-material bonding-sealing on absorbent surfaces and nonabsorbent.

PASTE:

plastic, PVC, wood, polyforte, polystyrene, cork, baseboards, metal, parquet, carpet, ceramics, stones, bricks.

Reserved for professional users.
Disposal: follow national directives.



Etichettatura di pericolo ai sensi del Regolamento (CE) 1272/2008 (CLP) e successive modifiche ed adeguamenti.

Avvertenze: -

Indicazioni di pericolo:

EUH210 Scheda di sicurezza disponibile su richiesta.
EUH208 Contiene: N-[3-(TRIMETOSSISILIL)PROPIL] ETILENDIAMMINA
Può provocare una reazione allergica.

Hazard labelling according to Regulation (EC) 1272/2008 (CLP) and subsequent amendments and adjustments.

Warnings: -

Hazard statements:

EUH210 Safety data sheet available on request.
EUH208 Contains: N-[3-(TRIMETHOXSILYL)PROPYL] ETHYLENEDIAMINE
It can cause an allergic reaction.

Articolo/Article	Confezione/Packages	Attrezzatura/Equipment	Caratteristiche/Characteristics
COL3591	 480 g Scatola da 12 pezzi / Box of 12 pieces		

COL1551 Adesivo universale monocomponente



Adesivo acrilico in dispersione acquosa, idoneo per la posa di pavimenti in PVC in teli e piastrelle, gomma civile, sughero supportato su PVC, moquette con retro in juta naturale o sintetica o in schiuma di PVC.

Da impiegare solo all'interno, su sottofondi assorbenti o scarsamente assorbenti.

COL1551 Universal adhesive one-component

Acrylic adhesive in water dispersion, suitable for laying of PVC flooring in tarpaulins and tiles, civil rubber, cork supported on PVC, carpet with back in natural jute or synthetic or PVC foam. To be used only indoors, on absorbent or poorly absorbent substrates.



Articolo Article	Confezione Packages	Consumo mq Consumption mq	Tempo di posa Exposure time	Attrezzatura Equipment	Caratteristiche Characteristics
COL1551	5 kg 	300 - 500 g	48 - 72 ore / hours		

ADHESIVES

COL1554

Adesivo per rivestimenti



Adesivo monocomponente a base di resine sintetiche e cariche minerali selezionate in dispersione acquosa, idoneo per la posa a parete e soffitto di pannelli e lastre di polistirolo, poliuretano e gesso; materiali fonoassorbenti e termoisolanti, piastrelle ceramiche, mosaico su sottofondi assorbenti. Se i materiali da incollare sono assorbenti è possibile la posa su sottofondi non assorbenti, purché non metallici.

COL1554

Adesivo per rivestimenti

One-component adhesive based on synthetic resins and selected mineral fillers in water dispersion, suitable for wall and ceiling installation of polystyrene, polyurethane and plaster panels and slabs; sound-absorbing and heat-insulating materials, ceramic tiles, mosaic on absorbent substrates. If the materials to be glued are absorbent it is possible to lay on non-absorbent substrates, provided they are not metallic.



Articolo Article	Confezione Packages	Consumo mq Consumption mq	Tempo di presa Setting time	Attrezzatura Equipment	Caratteristiche Characteristics
COL1554	5 kg 	500 - 2000 g	48 ore / hours		

COL3092

Resopast 105



Prodotto in pasta in dispersione acquosa pronto all'uso, idoneo per la rasatura di sottofondi cementizi, pavimentazioni di ceramica, marmo, palladiana, gres e pannelli in legno. Specifico come aggrappante per successive rasature cementizie.

COL3092

Resopast 105

Product in ready-to-use water dispersion paste, suitable for shaving cement substrates, ceramic, marble, palladian, stoneware and wood panels. Specific as clinging for subsequent cementitious shaving.



Articolo Article	Confezione Packages	Consumo Consumption	Tempo di presa Setting time	Attrezzatura Equipment	Caratteristiche Characteristics
COL3092	15 kg 	1,2 kg / mm	2 - 8 ore / hours		



COL3093 Hycol KD 1 Special

Adesivo acrilico universale in dispersione acquosa ad elevata presa iniziale, a lungo tempo aperto, idoneo per la posa di pavimenti e rivestimenti in PVC omogeneo ed eterogeneo, gomma civile, sughero supportato su PVC, profili in PVC. Specifico per rivestimenti in PVC e gomma su sottofondi di assorbenti o scarsamente assorbenti.

COL3093 Hycol KD 1 Special

Universal acrylic adhesive in water dispersion with high initial grip, long open time, suitable for laying floors and coatings in homogeneous and heterogeneous PVC, civil rubber, cork supported on PVC, PVC profiles. Specific for PVC and rubber coverings on absorbent or poorly absorbent undercoats.



Articolo Article	Confezione Packages	Consumo mq Consumption mq	Tempo di presa Setting time	Attrezzatura Equipment	Caratteristiche Characteristics
COL3093	5 kg 	300 - 500 g	48 - 72 ore / hours	n. 1 - n. 2 	



COL3096 Gommapol

Adesivo bicomponente epossi-poliuretano ad alte prestazioni, idoneo per l'incollaggio di pavimenti di gomma civile e sportiva, PVC in teli e piastre, pavimenti tessili e linoleum su sottofondi assorbenti e non assorbenti compreso asfalto. Idoneo in ambienti commerciali ed industriali ad alto traffico.

COL3096 Gommapol

Two-component, high-performance polyurethane-epoxy adhesive, suitable for bonding civil and sports rubber floors, PVC sheets and plates, textile and linoleum floors on absorbent and non-absorbent substrates including asphalt. Suitable in high traffic commercial and industrial environments.



Articolo Article	Confezione Packages	Consumo mq Consumption mq	Tempo di presa Setting time	Attrezzatura Equipment	Caratteristiche Characteristics
COL3096	5 kg 	800 - 1200 g	48 ore / hours	n. 2 - n. 4 	

Avvertenze e condizioni generali di vendita

La Colori in Casa-Teykos si riserva il diritto di effettuare qualsiasi modifica o eliminare qualunque prodotto senza preavviso alcuno. Le foto, le misure e tutte le informazioni riferite ai prodotti non sono vincolanti e sono suscettibili di variazioni. E' vietata la riproduzione di testi o disegni salvo specifica autorizzazione della Colori in Casa-Teykos.

Le condizioni generali di vendita che regolano i rapporti commerciali con la clientela, sono presenti nel listino in vigore.

Per ogni controversia il foro di competenza è quello di Siena.

Notices and general conditions of sale

Colori in Casa-Teykos reserves the right to make changes or eliminate whatever product without notice. Pictures, measurements and every information referring to products are not binding and could be modified. Text's reproduction or drawings is prohibited unless specifically authorized by Colori in Casa-Teykos.

General conditions of sale which regulate commercial customers relations are present in the current price list.

For any dispute, the competent forum is Court of Siena.



Listino prezzi.
Price list.

Stampato nel mese di giugno 2021 - Printed in June 2021



COLORI IN CASA srl

Sede e stabilimento:
Pian dell'Olmino / Santa Giulia, 61
53034 Colle di Val d'Elsa (SI)
Tel. 0577 / 929934 - Fax 0577 / 904917
www.coloriincasa.com
info@coloriincasa.com
www.teykos.it

