



  
**teykos**<sup>®</sup>  
by COLORI IN CASA

Illuminotecnica in gesso



| Luci parete  
| Luci incasso parete  
| Luci incasso soffitto  
| Luci soffitto  
| Luci incasso parete/soffitto



**teykos**<sup>®</sup>  
by COLORI IN CASA



# Illuminotecnica in gesso

- ▶ Luci da parete
- ▶ Luci da incasso parete
- ▶ Luci da incasso soffitto
- ▶ Luci da soffitto
- ▶ Luci da incasso parete/soffitto

## ▶ Luci da parete

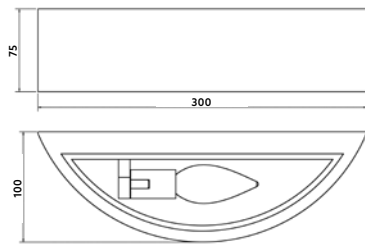

Voltaggio	Frequenza	Attacco luce	Watt
220-240V	50Hz	E14	40W



**IL3407**



**IL3408**

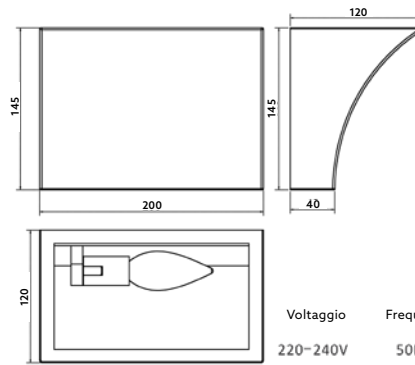

Voltaggio	Frequenza	Attacco luce	Watt
220-240V	50Hz	E14	40W

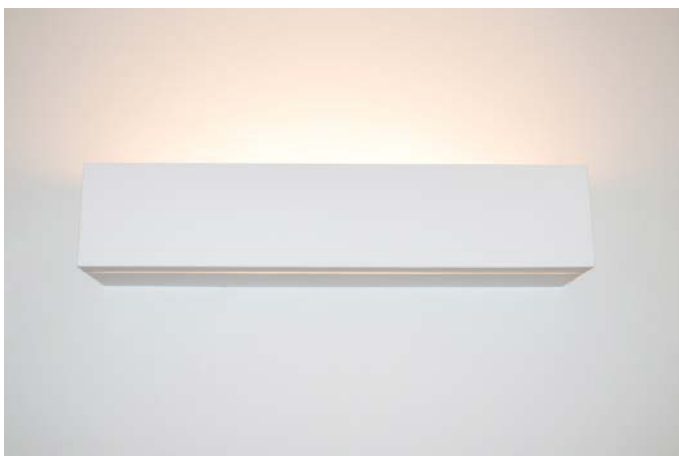

**IL3413**

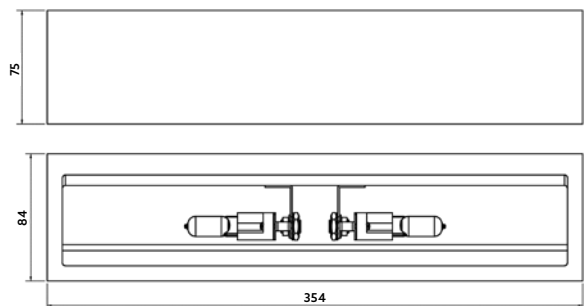

Voltaggio	Frequenza	Attacco luce	Watt
220-240V	50Hz	2xg9	2x35W





**IL2600**



Voltaggio	Frequenza	Attacco luce	Watt
220-240V	50Hz	E14	40W



Voltaggio	Frequenza	Attacco luce	Watt
220-240V	50Hz	G9	40W



**IL2601**

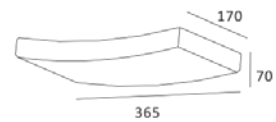

Voltaggio	Frequenza	Attacco luce	Watt
220-240V	50Hz	R7S	100W



**IL2603**

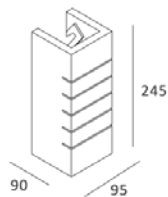

Voltaggio	Frequenza	Attacco luce	Watt
220-240V	50Hz	E14	40W

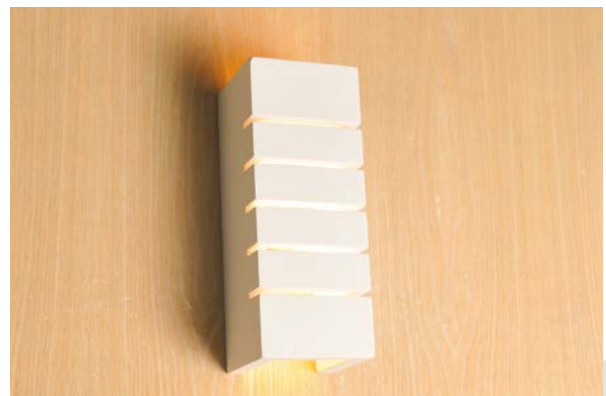

**IL2602**



# Illuminotecnica in gesso

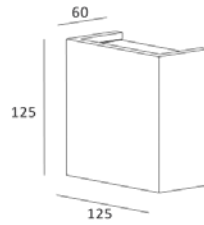

Voltaggio	Frequenza	Attacco luce	Watt
220-240V	50Hz	GREE XP-E	2x2W/LED

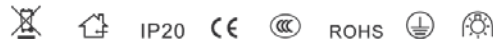

**IL2605** CORREDATA DI TRASFORMATORE E LED

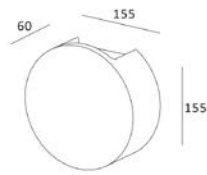

Voltaggio	Frequenza	Attacco luce	Watt
Voltage	Frequency	Light Source	Wattage
220-240V	50Hz	CREE XP-D	MAX 2x2W/LED



**IL2867** CORREDATA DI TRASFORMATORE E LED

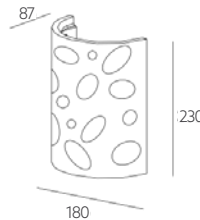

Voltaggio	Frequenza	Attacco luce	Watt
220-240V	50Hz	E14	40W

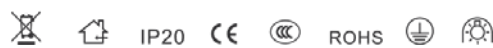

**IL2604**



**IL2606**

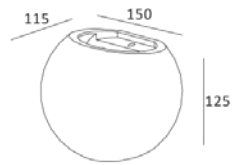

Voltaggio	Frequenza	Attacco luce	Watt
220-240V	50Hz	G9	40W

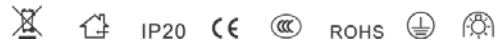

**IL2607**

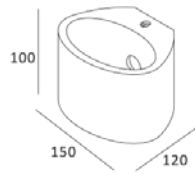

Voltaggio	Frequenza	Attacco luce	Watt
220-240V	50Hz	G9	40W



**IL2608**

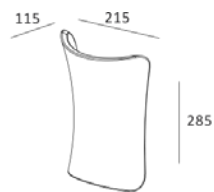

Voltaggio	Frequenza	Attacco luce	Watt
220-240V	50Hz	E14	40W

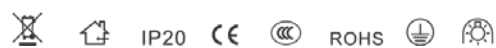



# Illuminotecnica in gesso



IL2868

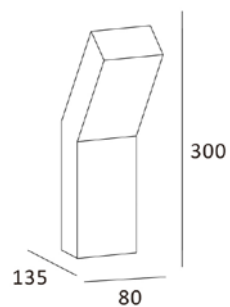

Voltaggio	Frequenza	Attacco luce	Watt
220-240V	50Hz	G9	MAX 40W



## ► Luci da incasso parete



IL2609

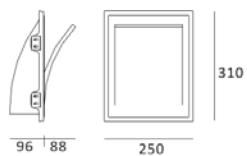

Voltaggio	Frequenza	Attacco luce	Watt
220-240V	50Hz	E14	MAX 40W



Voltaggio	Frequenza	Attacco luce	Watt
220-240V	50Hz	G9	MAX 40W



IL2611



IL2610

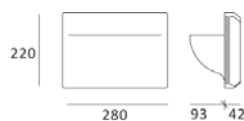

Voltaggio	Frequenza	Attacco luce	Watt
220-240V	50Hz	E14	MAX 40W







# Illuminotecnica in gesso



**IL2614**

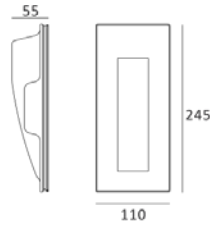

	Voltaggio	uscita in corrente costante	Attacco luce	Watt
	DC 3. 2V	350mA	CREE XP-E	1x1W/LED
	IP20			
			ROHS	



**IL2615** CORREDATA DI TRASFORMATORE E LED

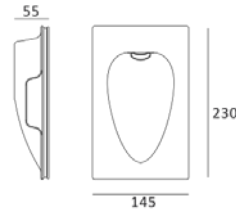

	Voltaggio	uscita in corrente costante	Attacco luce	Watt
	DC 3. 2V	350mA	CREE XP-E	1x1W/LED
	IP20			
			ROHS	



**IL2616**

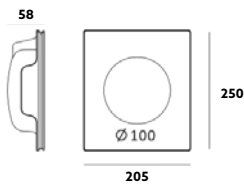

	Voltaggio	uscita in corrente costante	Attacco luce	Watt
	220-240V	HZ50	GU10	MAX35W
	IP20			
			ROHS	

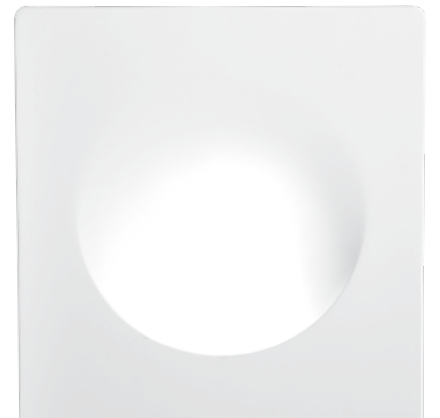

**IL2617**

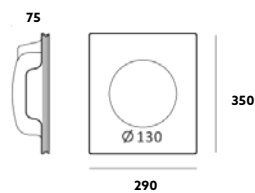

	Voltaggio	uscita in corrente costante	Attacco luce	Watt
	220-240V	HZ50	GU10	MAX35W
	IP20			
			ROHS	

## ► Luci da incasso soffitto

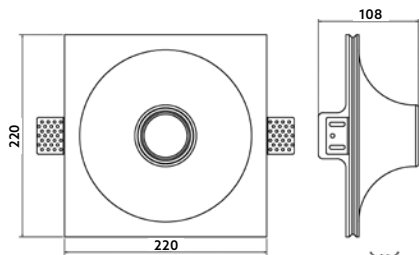

Voltaggio	Frequenza	Attacco luce	Watt
220-240V	50Hz	GU10	35/50W



**IL3417**



**IL3419**

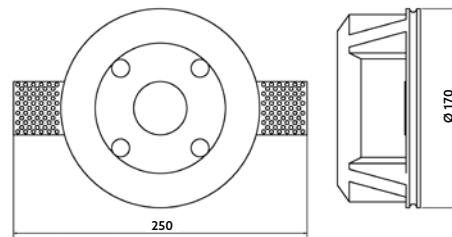

Voltaggio	Frequenza	Attacco luce	Watt
220-240V	50Hz	GU10	35/50W

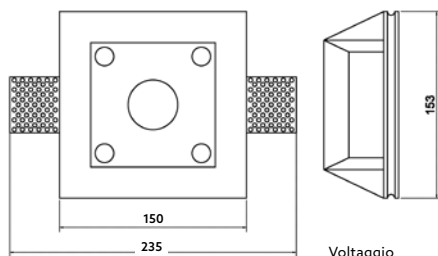

Voltaggio	Frequenza	Attacco luce	Watt
220-240V	50Hz	GU10	35/50W

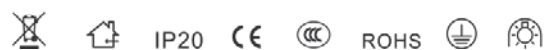

**IL3420**



# Illuminotecnica in gesso

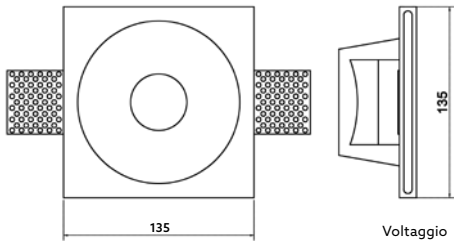

Voltaggio	Frequenza	Attacco luce	Watt
220-240V	50Hz	GU10	35/50W



IL3423



IL2883

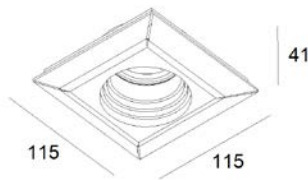

Voltaggio	Frequenza	Attacco luce	Watt
220-240V	50Hz	GU10	MAX 50 W

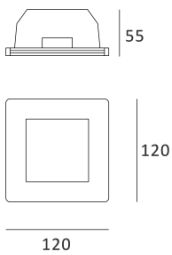

Voltaggio	Frequenza	Attacco luce	Watt
220-240V	50Hz	GU10	MAX 50 W

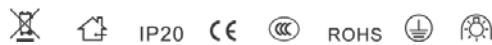

IL2618

Voltaggio	Frequenza	Attacco luce	Watt
220-240V	50Hz	GU10	<b>MAX 50 W</b>

IP20
 

 ROHS

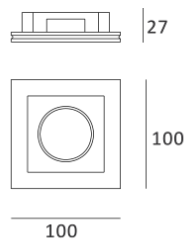
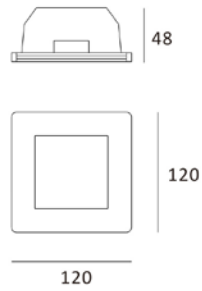

Voltaggio	Frequenza	Attacco luce	Watt
220-240V	50Hz	GU10	<b>MAX 50 W</b>

IP20
 

 ROHS

Voltaggio	Frequenza	Attacco luce	Watt
220-240V	50Hz	GU10	<b>MAX 50 W</b>

IP20
 

 ROHS

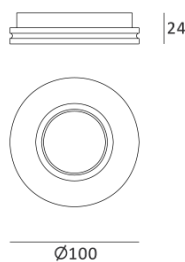
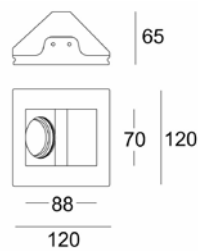

Voltaggio	Frequenza	Attacco luce	Watt
220-240V	50Hz	GU10	<b>MAX 50 W</b>

IP20
 

 ROHS



# Illuminotecnica in gesso

Voltaggio	Frequenza	Attacco luce	Watt
220-240V	50Hz	GU10	MAX 50 W

IP20
 

 ROHS



IL2884



IL2885

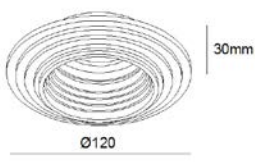

Voltaggio	Frequenza	Attacco luce	Watt
220-240V	50Hz	GU10	MAX 50 W

IP20
 

 ROHS

Voltaggio	Frequenza	Attacco luce	Watt
220-240V	50Hz	GU10	MAX 50 W

IP20
 

 ROHS



IL2662



IL2664 DIFFUSORE ORIENTABILE

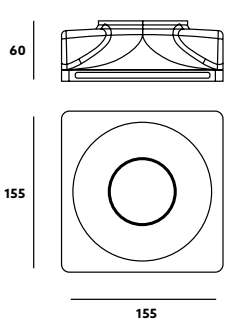

Voltaggio	Frequenza	Attacco luce	Watt
220-240V	50Hz	GU10	MAX 50 W

IP20
 

 ROHS

	Voltaggio	Frequenza	Attacco luce	Watt
	220-240V	50Hz	GU10	<b>MAX 50 W</b>



 IP20
 

 ROHS
 



**IL2619**



**IL2872**

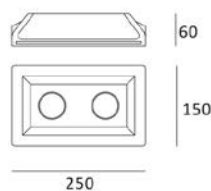

	Voltaggio	Frequenza	Attacco luce	Watt
	220-240V	50Hz	GU10	<b>MAX 50 W</b>



 IP20
 

 ROHS
 

	Voltaggio	Frequenza	Attacco luce	Watt
	220-240V	50Hz	GU10	<b>MAX 50 W</b>



 IP20
 

 ROHS
 

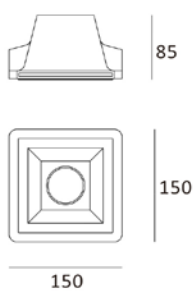
**IL2887**



**IL2888**

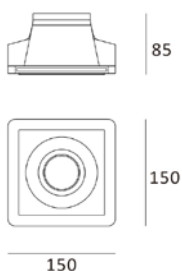

	Voltaggio	Frequenza	Attacco luce	Watt
	220-240V	50Hz	GU10	<b>MAX 50 W</b>



 IP20
 

 ROHS
 



# Illuminotecnica in gesso



**IL2873**

Voltaggio	Frequenza	Attacco luce	Watt
220-240V	50Hz	GU10	MAX 50 W



**IL2875**

Voltaggio	Frequenza	Attacco luce	Watt
220-240V	50Hz	CDM-R PAR30	MAX 70W

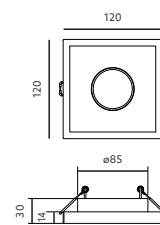
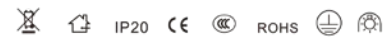

**IL3668**

Voltaggio	Frequenza	Attacco luce	Watt
220-240V	50Hz	GU10	MAX 50 W

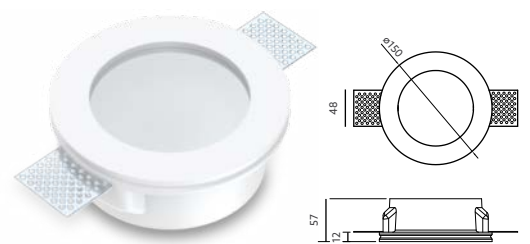

**IL3669**

Voltaggio	Frequenza	Attacco luce	Watt
220-240V	50Hz	GU10	MAX 50 W





## ► Luci da soffitto



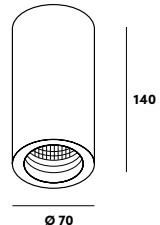

**IL2659**



Voltaggio	Frequenza	Attacco luce	Watt
220-240V	50Hz	GU10	MAX 50W

 IP20
 







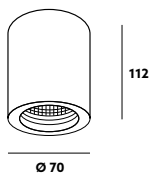



**IL2658**



Voltaggio	Frequenza	Attacco luce	Watt
220-240V	50Hz	GU10	MAX 50W

 IP20
 







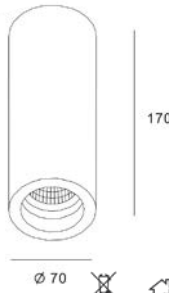





**IL2870**



Voltaggio	Frequenza	Attacco luce	Watt
220-240V	50Hz	GU10	MAX 35W

 IP20
 







# Illuminotecnica in gesso



**IL2612**

Voltaggio	Frequenza	Attacco luce	Watt
220-240V	50Hz	GU10	MAX 35W

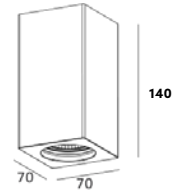
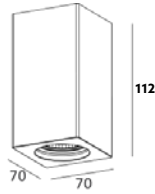

**IL2613**

Voltaggio	Frequenza	Attacco luce	Watt
220-240V	50Hz	GU10	MAX 35W

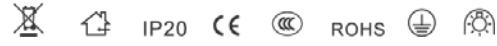

**IL 2869**

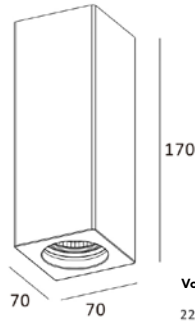

Voltaggio	Frequenza	Attacco luce	Watt
220-240V	50Hz	GU10	MAX 35W



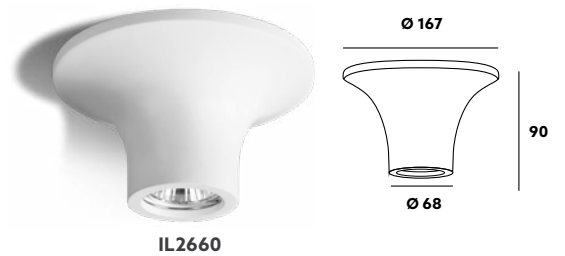

**IL2660**

Voltaggio	Frequenza	Attacco luce	Watt
220-240V	50Hz	GU10	MAX 35W



**IL2661**

Voltaggio	Frequenza	Attacco luce	Watt
220-240V	50Hz	GU10	MAX 35W



**IL2886**

Voltaggio	Frequenza	Attacco luce	Watt
-----------	-----------	--------------	------

Voltage	Frequency	Light Source	Wattage
220-240V	50Hz	GU10	MAX 35W







# Illuminotecnica in gesso

## ► Luci da incasso parete/soffitti

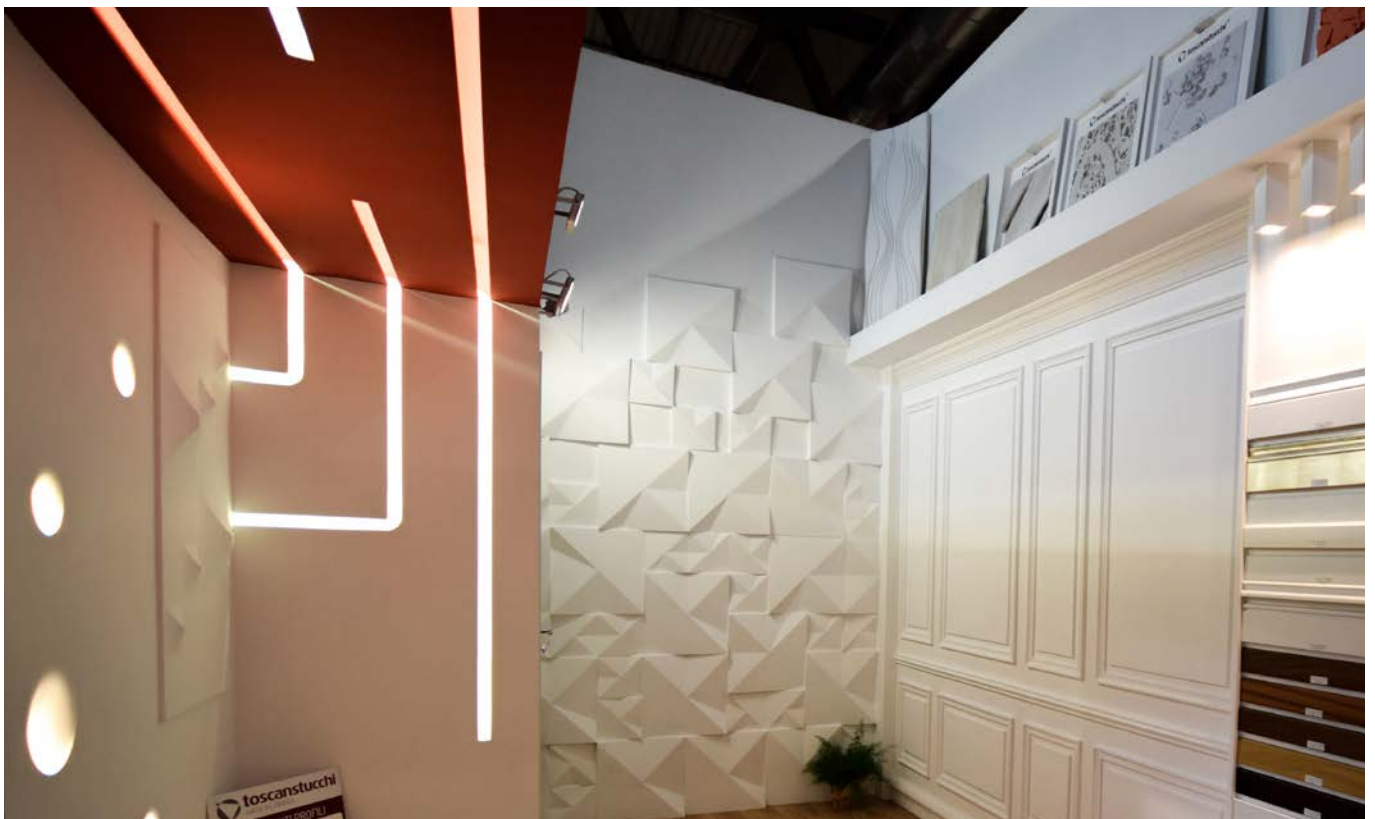
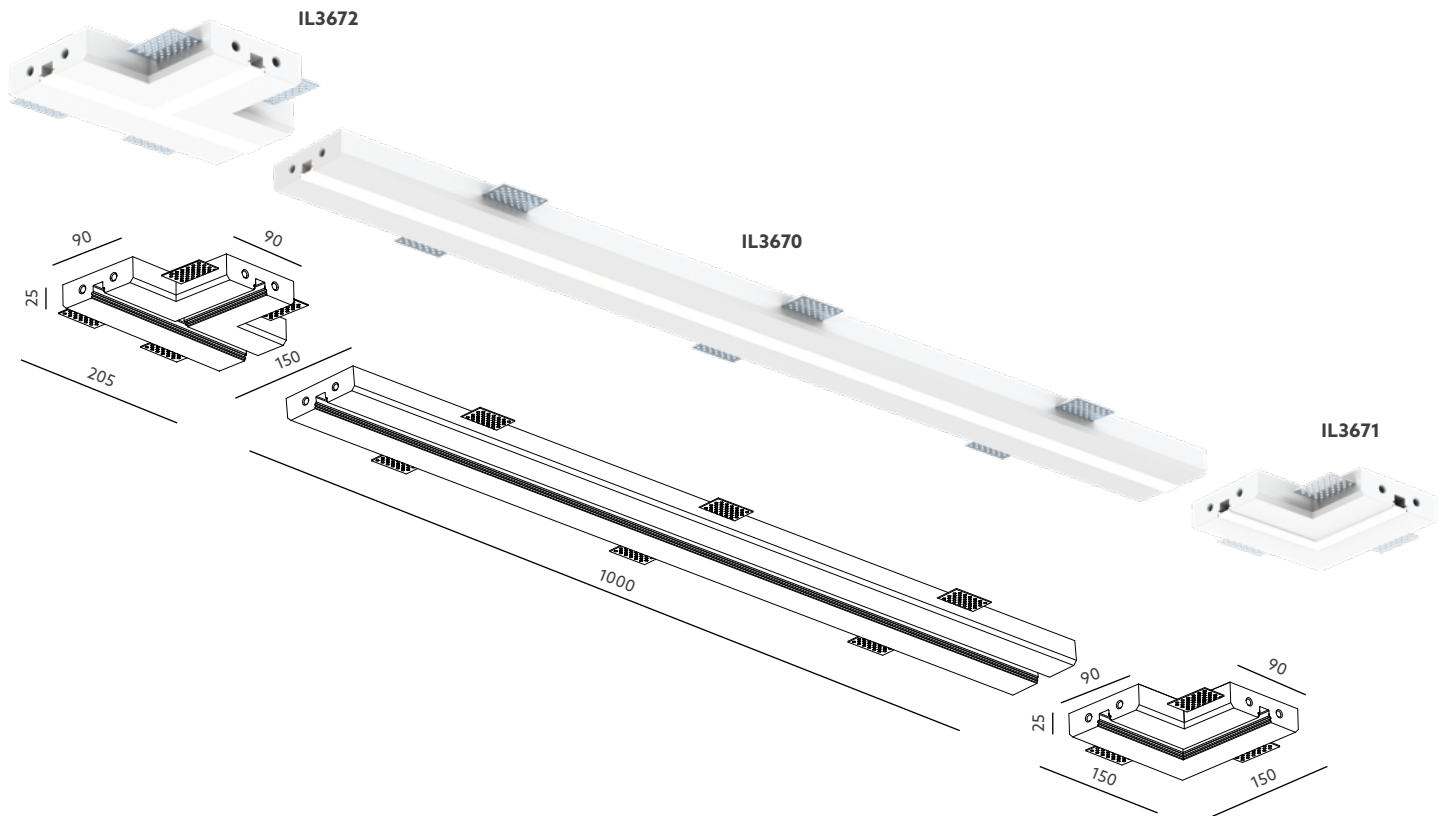



**IL2878**

PARTE ELETTRICA NON INCLUSA



**IL2879**

PARTE ELETTRICA NON INCLUSA



**IL2880**

PARTE ELETTRICA NON INCLUSA

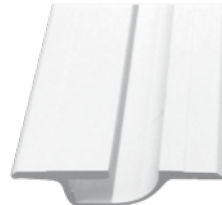

**IL2622**

PARTE ELETTRICA NON INCLUSA  
lunghezza 1 m.

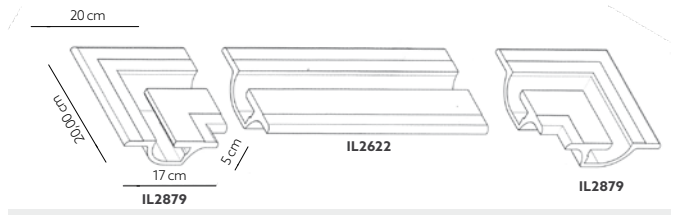
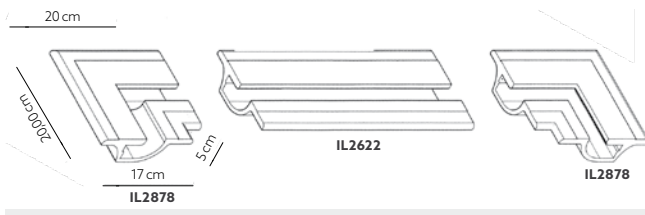
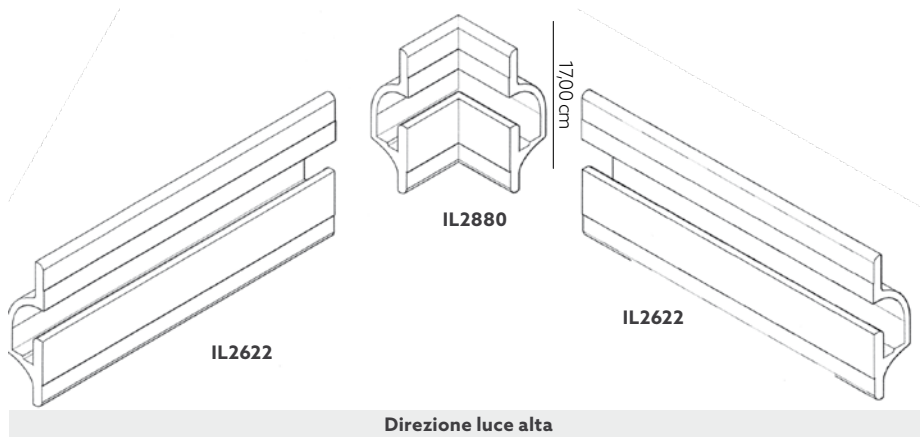

**IL2881** PARTE ELETTRICA NON INCLUSA

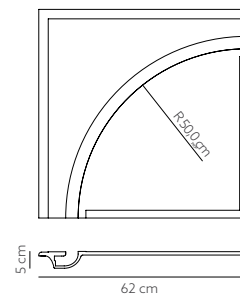

**IL2882** PARTE ELETTRICA NON INCLUSA

